





QUICK START

QUICK START GUIDE • GUÍA DE INICIO RÁPIDO

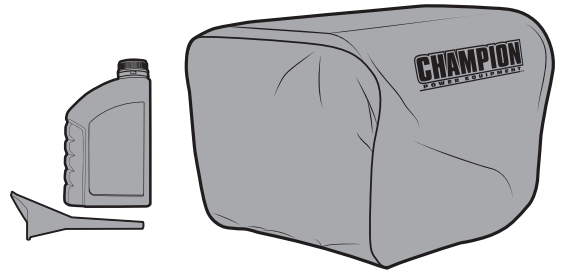

PARTS INCLUDED / Partes incluidas





DANGER / PELIGRO



MOVE GENERATOR OUTDOORS
 Using a generator indoors CAN KILL YOU IN MINUTES. Generator exhaust contains carbon monoxide. This is a poison you cannot see or smell.
NEVER use inside a home or garage, **EVEN IF** doors and windows are open.
ONLY use **OUTSIDE** and far away from windows, doors, and vents.

MUEVA EL GENERADOR AL INTERPERIE
 El uso de un generador en interiores PUEDE MATARLO EN MINUTOS. El escape del generador contiene monóxido de carbono. Éste es un veneno que no se puede ver ni oler.
NUNCA lo use dentro del hogar ni el garaje, **INCLUSO SI** las puertas y ventanas están abiertas.
 Úselo **SÓLO** a la **INTEMPERIE** lejos de ventanas, puertas, y orificios de ventilación.



WARNING / ADVERTENCIA



Read the **ENTIRE** operator's manual to become familiar with the features of this product before operation. This QuickStart Guide IS NOT a substitute for the Operator's Manual.
 Failure to operate the product correctly could result in damage to the product, personal property or cause serious injury or death.

Lea el manual del operador COMPLETO para familiarizarse con las características de este producto antes de la operación. Esta guía de inicio rápido NO es un sustituto del Manual del operador.

La falta de operación correcta del producto podría resultar en daños al producto, propiedad personal, o causar lesiones graves o la muerte.

NOTICE / AVISO

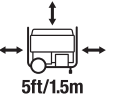

Keep all objects at least 5 feet (1.5 m) from generator. Heat from the muffler and exhaust gas can ignite combustible materials.

Mantenga todos los objetos por lo menos 5 pies (1.5m) del generador. El calor del silenciador y el gas del escape pueden incendiar objetos combustibles.

1.

Remove brackets.  Assembly > Remove Shipping Support Brackets.

Remueva las ménsulas.

 Montaje > Remueva las Ménsulas de Soporte de Envío.

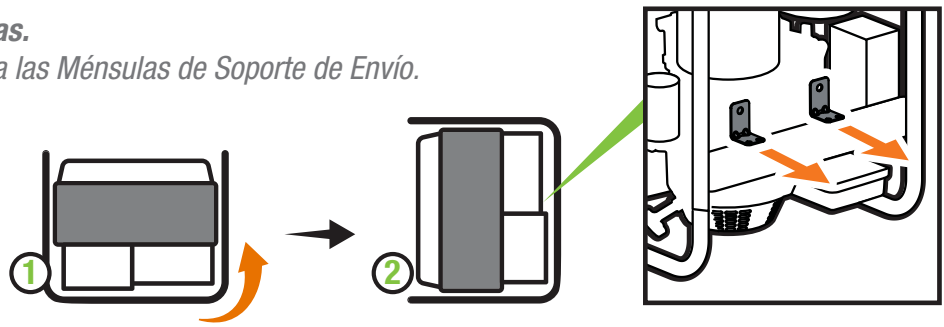

2.

Attach wheel kit.  Assembly > Install Wheel Kit

Fije el juego de ruedas.

 Montaje > Instale el Juego de Ruedas

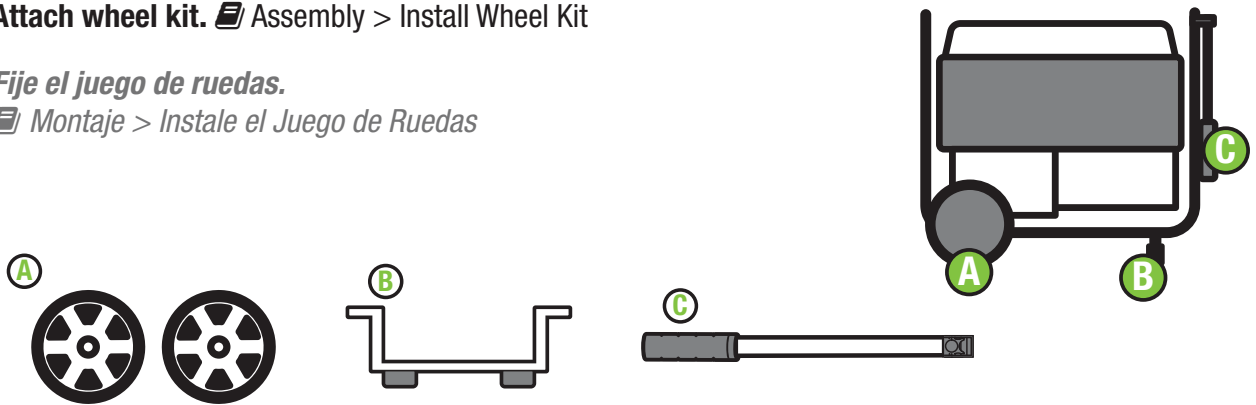

3.

Add oil.  Assembly > Add Engine Oil

Recommended: 10W-30, up to 16.9 fl. oz. (500 ml). DO NOT overfill.

Agregue aceite.  Montaje > Agregue Aceite al Motor

Recomendado: 10W-30, hasta 16.9 fl. oz. (500 ml). NO sobrellene.



MAKE SURE SHIPPING BRACKETS ARE REMOVED BEFORE ADDING OIL.

ASEGURE QUE LAS MÉNSULAS DE ENVÍO ESTÉN REMOVIDAS ANTES DE AGREGAR ACEITE

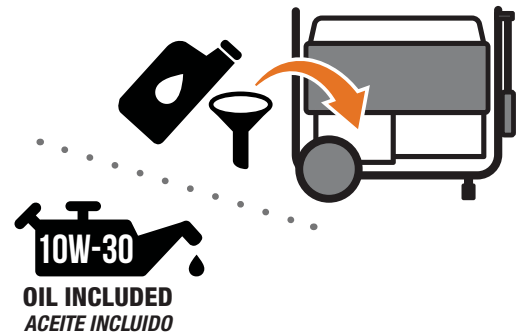

10W-30
OIL INCLUDED
ACEITE INCLUIDO

4.

Move the generator outdoors. / *Mueva el generador afuera.*



ONLY USE OUTSIDE AND FAR AWAY FROM WINDOWS, DOORS, AND VENTS.

ÚSELO SÓLO A LA INTEMPERIE LEJOS DE VENTANAS, PUERTAS, Y ORIFICIOS DE VENTILACIÓN.



5.

Add fuel. 📖 Assembly > Add Fuel: Gasoline

DO NOT use E15 or E85.

Agregue combustible.

📖 Montaje > Agregue combustible.



DO NOT USE E15 OR E85.

NO USE E15 O E85.



6.

DO NOT plug in any electrical devices.

NO enchufe ningún aparato electrónico.



NEVER START OR STOP THE GENERATOR WITH ELECTRICAL DEVICES CONNECTED OR TURNED ON!

¡NUNCA ENCIENDA UN GENERADOR CON APARATOS ELECTRONICOS ENCHUFADOS O ENCENDIDOS!

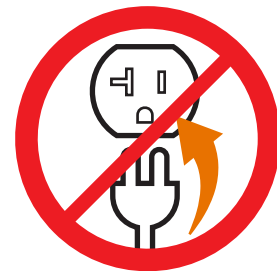

7.

Turn the **fuel valve** “ON”.

*Abra la **válvula de combustible** a “ENCENDIDO”.*



8.

Press the **engine switch** to the “ON” position.

*Oprima el **interruptor del motor** a la posición “ENCENDIDO”.*

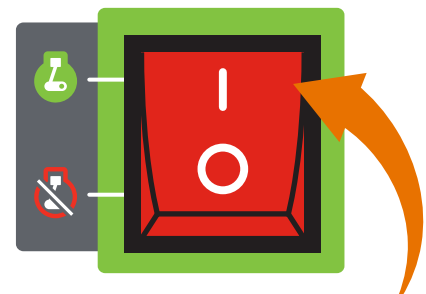

⚡ START UP / Arrancar

- 9.** Move the **choke lever** to the “CHOKE” position.
*Mueva la **palanca del ahogador** a la posición “AHOGAR.”*

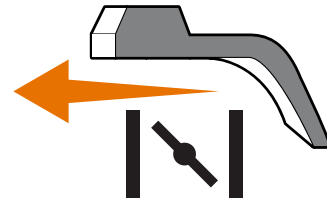

- 10.** Pull the **recoil** to start the engine.
*Jale el **arrancador retráctil** para encender el motor.*

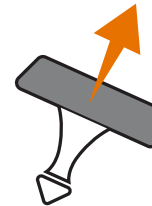

- 11.** Move the **choke lever** to the “RUN” position.
*Mueva la **palanca del ahogador** en la posición “CORRER.”*

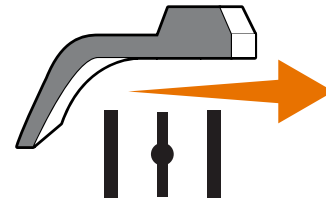

- 12.** Plug in.  Operation > Connecting Electrical Loads.
Enchufe.  Operación > Conectando Cargas Eléctricas.

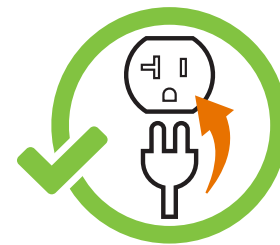

 YouTube

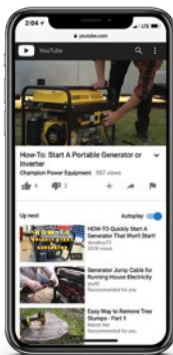

Visit our YouTube channel to watch our how-to videos and subscribe to view our latest videos on our Champion Power Equipment products!

Visite nuestro canal de YouTube para ver nuestros videos de guías o suscribase para ver los videos más recientes en nuestros productos Champion Power Equipment.



1-877-338-0999

CHAMPIONPOWEREQUIPMENT.COM



TAKEYOURGENERATOROUTSIDE.COM