

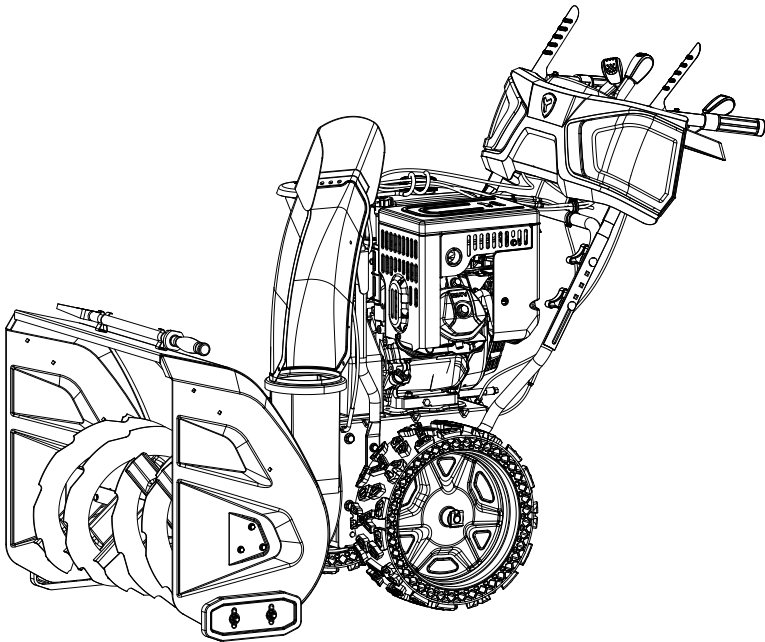

YARDWORKS^{®/MD}

Snowblower

model number 060-4012-4 | contact us: 1.866.523.5218



IMPORTANT: Please read this manual carefully before operating this snowblower and save it for reference.

⚠ WARNING: Machine is without engine oil. Properly fill engine oil prior to use to prevent engine damage.

TABLE OF CONTENTS	2
SAFETY INSTRUCTIONS	3
SAFETY SYMBOLS	7
OPERATION SYMBOLS	9
SPECIFICATIONS	11
ASSEMBLY	14
OPERATION	20
STARTING THE ENGINE	24
CONTROLS	27
MAINTENANCE	31
TROUBLESHOOTING	33
WARRANTY	34



For problems or questions, **DO NOT RETURN TO STORE.**
Please contact one of our Customer Service Agents
who would be happy to assist you.



For Customer Assistance Please Call:
1.866.523.5218

SAFETY DEFINITIONS

The purpose of safety symbols is to attract your attention to possible dangers. The safety symbols, and their explanations, deserve your careful attention and understanding. The safety warnings do not by themselves eliminate any danger. The instructions or warnings they give are not substitutes for proper accident prevention measures.

DANGER

DANGER indicates a hazardous situation which, if not avoided, will result in death or serious injury.

WARNING

WARNING indicates a hazardous situation which, if not avoided, could result in death or serious injury.

CAUTION

CAUTION indicates a hazardous situation which, if not avoided, could result in minor or moderate injury.

NOTICE

NOTICE indicates information considered important, but not hazard-related (e.g., messages relating to property damage).

GENERAL SAFETY

- Read the operating and service instruction manual carefully. Be thoroughly familiar with the controls and the proper use of the equipment. Know how to stop the unit and disengage the controls quickly.
- Never allow children under 16 years old to operate the equipment. Never

allow adults to operate the equipment without proper instruction.

- Thrown objects can cause serious injury. Keep the area of operation clear of all persons, particularly small children, and pets. Plan your snow discharge pattern to prevent throwing material toward cars, structures, roads and people.
- Exercise caution to avoid slipping or falling, especially when operating in reverse.
- Keep in mind that the operator or user is responsible for accidents or hazards occurring to other people or their property.
- Never use the snowblower under the influence of alcohol, medication, or recreational drugs, or if you are tired or ill.

PREPARATION FOR USE

- Thoroughly inspect the area where the equipment is to be used and remove all doormats, sleds, boards, wires, and other foreign objects.
- Disengage all clutch handles before starting the motor.
- Do not operate the equipment without wearing adequate winter garments. Wear footwear which will improve footing on slippery surfaces.
- Adjust the auger housing height to clear gravel or crushed rock surface.
- Never attempt to make any adjustments while the engine is running (except where specifically recommended in the manual).

- Let engine and machine adjust to outdoor temperatures before starting to clear snow.
- The operation of any powered machine can result in foreign objects being thrown into the eyes. Always wear safety glasses or eye shields during operation, or while performing an adjustment or repair.
- Inspect the auger and impeller before starting to ensure that there is no ice build up.
- Do not over fill fuel tank. Keep fuel level at least ½" (1.27 cm) below bottom of filler neck to provide space for fuel expansion.
- Replace gasoline cap and tighten securely.
- If gasoline is spilled, wipe it off the engine and equipment. Move machine to another area. Wait 5 minutes before starting the engine.
- Never store the machine or fuel container indoors where there is an open flame, spark or pilot light (e.g., furnace, water heater, space heater, clothes dryer etc.).

SAFE HANDLING OF GASOLINE

To avoid severe injury or property damage use high levels of care while handling gasoline. Gasoline is an extremely flammable substance and the vapours are explosive. Serious personal injury can occur when gasoline is spilled on yourself or your clothes, which can ignite. If you come into contact with gasoline, wash affected areas of skin and change clothing immediately.

- Use only an approved gasoline container.
- Extinguish all cigarettes, cigars, pipes and other sources of ignition prior to working with or near gasoline.
- Never refuel machine within closed spaces.
- Never remove gas cap or add fuel while the engine is hot or running.
- Allow engine to cool at least two minutes before refueling.
- Allow machine to cool at least 5 minutes before storing.
- Never fill containers inside a vehicle or on a truck or trailer bed with a plastic liner. Always place containers on the ground away from your vehicle before filling.
- If possible, remove gas-powered equipment from the truck or trailer and refuel it on the ground. If this is not possible, then refuel such equipment on a trailer with a portable container, rather than from a gasoline dispenser nozzle.
- Keep the nozzle in contact with the rim of the fuel tank or container opening at all times until fueling is complete. Do not use gas cans with nozzle lock-open devices.

OPERATION

- Do not put hands or feet near or under rotating parts. Keep clear of the discharge opening at all times.
- Exercise extreme caution when operating on or crossing gravel drives, walks, or roads. Stay alert for hidden hazards or traffic.
- After striking a foreign object, stop the engine, remove the spark plug, thoroughly inspect the snowblower for any damage, and repair the damage before restarting and operating the snowblower.
- If the unit should start to vibrate abnormally, stop the engine and check immediately for the cause. Vibration is generally a warning of trouble. Vibration typically indicates a mechanical problem has occurred.
- Stop the engine whenever you leave the operating position, before unclogging the auger housing or discharge guide, and when making any repairs, adjustments, or inspections.
- Before cleaning, inspecting or repairing any parts of the snowblower, ensure the auger has stopped moving. Disconnect the spark plug wire and keep it away from the plug to prevent accidental starting.
- Before leaving the machine unattended, disengage all control levers, stop the engine and remove the safety key.
- Do not run the engine indoors. Exhaust fumes are dangerous.
- Do not clear snow across the face of slopes. Exercise extreme caution when changing direction on slopes. Do not attempt to clear steep slopes.
- Never operate the snowblower without proper guards, plates or other safety protective devices in place.
- Never operate the snowblower near glass enclosures, automobiles, window wells, etc., without proper adjustment of the snow discharge angle. Keep children and pets away.
- Do not overload the machine capacity by attempting to clear snow at too fast a rate.
- Never operate the machine at high transport speeds on slippery surfaces. Use care when reversing.
- Never direct discharge at bystanders or allow anyone in front of the unit.
- Disengage power to the impeller when snowblower is transported or not in use.
- Use only attachments and accessories approved by the manufacturer of snowblower.
- Never operate the snowblower without good visibility or light. Always be sure of your footing, and keep a firm hold on the handles. Walk; never run.
- Take all possible precautions when leaving the machine unattended. Disconnect the power take-off and stop the engine.
- Keep all nuts, bolts and screws tight to be sure the equipment is in safe working condition.

- Replace worn or damaged parts for safety. Use only genuine replacement parts and accessories.
- This snowblower is not intended for use by persons (including children) with reduced physical, sensory or mental capabilities, or lack of experience and knowledge, unless they have been given supervision or instruction concerning use of the appliance by a person responsible for their safety.
- Be careful while working on the machine or clearing a blockage in the auger or impeller to ensure that fingers and hands do not become crushed or cut.
- Do not touch hot engine components like the muffler, muffler guard or engine block during operation of the snowblower as they will cause burns.
- Should the unit stop discharging snow for any reason, release the controls to stop and inspect for any lodged items or damaged parts in the auger housing.

CLEARING A CLOGGED DISCHARGE CHUTE

Hand contact with the rotating impeller inside the discharge chute is the most common cause of injury associated with snowblowers. Never use your hand to clean out the discharge chute or auger assembly.







To clear the chute:

- SHUT THE ENGINE OFF!
- Wait 10 seconds to be sure the impeller blades have stopped rotating.
- Always use a clean-out tool. DO NOT use your hands.

MAINTENANCE AND STORAGE









- Check shear bolts, engine mounted bolts, etc., at frequent intervals for proper tightness to sure the equipment is in safe, working condition.
- Never store the machine with fuel in the fuel tank inside a building where ignition sources are present such as hot water heaters, space heaters, clothes dryers or any open flame sources. Allow the engine to cool before storing in any enclosure.
- Always refer to owner's guide instructions for important details if the snowblower is to be stored for an extended period.
- Maintain or replace safety and instructions labels, as necessary.
- Run the snowblower for one minute to clear out packed snow and ice to prevent freeze-up during storage.

Some of the following symbols may be used on this product. Please study them and learn their meaning. Proper interpretation of these symbols will allow you to more safely operate the product.

Symbol	Meaning
	<p>Read Operator's Manual. To reduce the risk of injury, user must read and understand operator's manual before using this product.</p>
	<p>Eye and Ear Protection. Always wear safety goggles or safety glasses with side shields, and as necessary a full face-shield as well as full ear protection when operating this product.</p>
	<p>Safety Alert. Precautions that involve your safety.</p>
	<p>Risk of Fire/Explosion. Fuel and its vapours are extremely flammable and explosive. Fire can cause severe burns or death. Do not add fuel while the product is operating or still hot.</p> <p>Open Flame Alert. Fuel and its vapours are extremely flammable and explosive. Keep fuel away from smoking, open flames, sparks, pilot lights, heat, and other ignition sources.</p>
	<p>Electric Shock. Failure to use the starter in dry conditions and to observe safe practices can result in electric shock.</p>
	<p>Toxic Fumes. The engine exhaust from this product contains chemicals known to cause cancer and birth defects and other reproductive harm.</p> <p>Risk of Asphyxiation. This engine emits carbon monoxide, an odourless, colourless poison gas. Breathing carbon monoxide can cause nausea, fainting or death. Use only in a well-ventilated area.</p>

Symbol	Meaning
	<p>Thrown Objects. This machine may pick up and throw objects which can cause serious personal injury.</p>
	<p>Always Use Chute Tool. Never use your hands to clear a clogged chute assembly. Shut OFF engine and remain behind handles until all moving parts have stopped before unclogging.</p>
	<p>Hot Surface. To reduce the risk of injury or damage, avoid contact with any hot surface.</p>
	<p>Risk of Fire. Fuel and its vapours are extremely flammable and explosive. Fire can cause severe burns or death. Do not add fuel while the product is operating or still hot.</p>
	<p>Rotating Auger. DANGER: Avoid injury from rotating auger — keep feet away.</p>
	<p>Rotating Blades. Never put your hand in the chute. Contact with rotating parts can amputate fingers and hands.</p>

Some of the following symbols may be used on this product. Please study them and learn their meaning. Proper interpretation of these symbols will allow you to more safely operate the product.

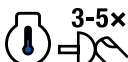
Symbol	Meaning
	Check Oil Level. Recommended oil is 0W-30. The engine can be seriously damaged without oil. Always check the oil level before using. The machine must be resting firmly on level ground when checking.
	Check Fuel Level. Use clean, fresh, regular unleaded gasoline with a minimum octane rating of 87 and an ethanol content of less than 10% by volume.
	Minimum Octane. Use clean, fresh, regular unleaded gasoline with a minimum octane rating of 87 and an ethanol content of less than 10% by volume.
	Fuel Valve: ON. Move the fuel valve lever to the on position.
	Choke: ON. To start a cold engine, move the choke lever to the choke position.
	Throttle: Full Speed. Move the throttle lever to full speed to start the engine.
	Throttle: Low Speed. Lowers the speed of the engine.
	Insert Engine Key. Make sure the engine safety key is inserted into the key hole.
	Cold Prime. To start a cold engine, prime 3-5 times.

OPERATION SYMBOLS

Symbol	Meaning
	<p>Warm Prime. To start a warm engine, DO NOT prime.</p>
	<p>Recoil Start. Pull the recoil starter grip to start manually.</p>
	<p>Choke: OFF. When the engine starts, move the choke to run position.</p>
	<p>Fuel Valve: OFF. Move the fuel valve lever to the OFF position.</p>
	<p>Remove Engine Key. Remove the engine key.</p>
	<p>Engine Stop.</p>

SNOWBLOWER

Stages	2
Speed Control	6 forward/2 reverse
Clearing Width	27" (69 cm)
Clearing Depth	23" (58 cm)
Impeller Diameter	12" (31 cm)
Wheel Diameter	15" (38 cm)
Auger Diameter	14" (36 cm)

ENGINE

Brand	Champion Power Equipment
Displacement	301 cc
Engine Model	R300S
Start Type	Electric, Recoil

OIL

Oil Capacity	37.2 fl. oz. (1.1 L)
Oil Type	0W-30

FUEL

Use clean, fresh, regular unleaded gasoline with a minimum octane rating of 87 and an ethanol content of less than 10% by volume.

Fuel Capacity	1.5 gal. (5.8 L)
----------------------	------------------

SPARK PLUGS

OEM Spark Plug	F6RTC
Replacement Spark Plug	NGK BPR6ES or equivalent
Spark plug gap	0.028 – 0.031" (0.7 – 0.8 mm)

BELTS

OEM Auger Belt	Gates 5LXA985E (L × W × H = 985 × 12.1 × 6.7)
OEM Drive Belt	Megadyne HTD 880-5M15 (L × W = 880 × 15 / Pitch = 5 mm)

SNOWBLOWER

- A. Discharge Chute Rotation Lever
- B. Auger Control Lever
- C. Speed Control Lever
- D. Shear Pin Storage
- E. Discharge Chute Deflector Lever
- F. Self-drive Control Lever
- G. Grip Heat Warmer Switch
- H. Clean-out Tool
- I. Upper Handle
- J. Discharge Chute Deflector
- K. Discharge Chute
- L. Auger
- M. Shave Plate
- N. Skid Shoes
- O. Auger Housing
- P. Wheels
- Q. Lower Handle
- R. Handle Locking Knobs
- S. Lights

ENGINE

- A. Key (Safety Lock Out)
- B. Primer Bulb
- C. Throttle Lever
- D. Choke Lever
- E. Fuel Valve (On/Off)
- F. Fuel Cap
- G. Electric Start Button
- H. Recoil Starter Grip
- I. Oil Fill and Level Check Cap
- J. Oil Drain Plug

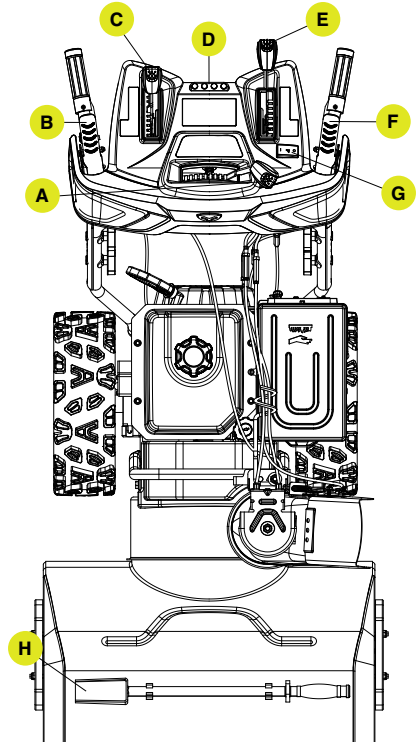

SPECIFICATIONS

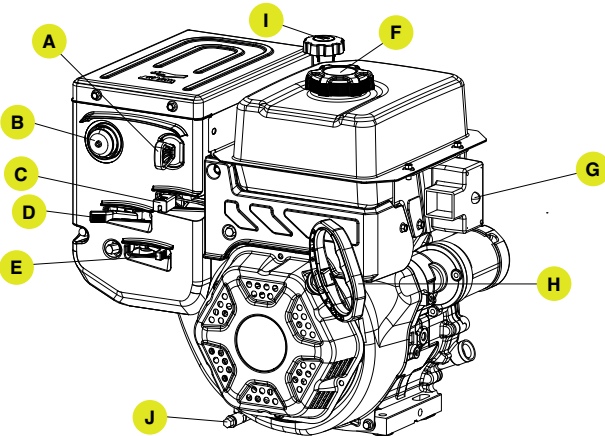
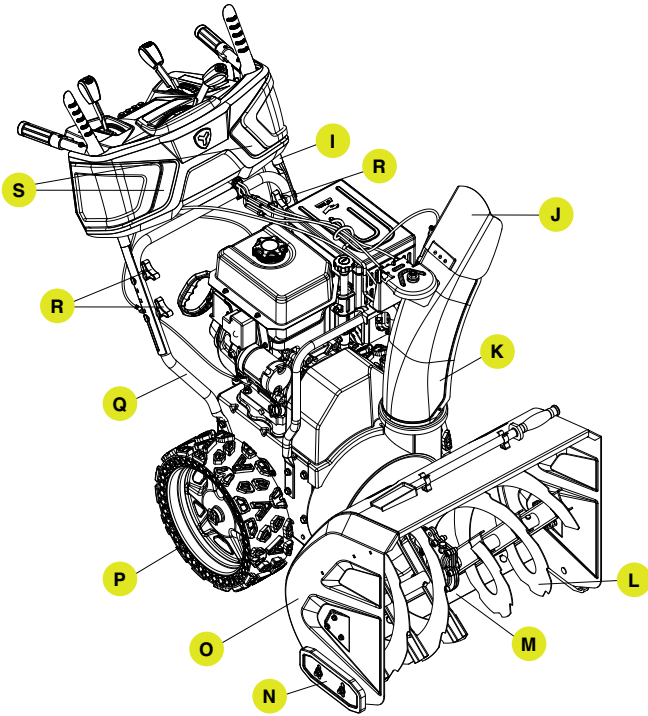

UNPACKING

1. Set the shipping carton on a solid, flat surface.
2. Remove everything loose from the carton.
3. Cut down the bottom carton to allow a flat surface area to install the assembly parts without scratching parts or cutting tires.
4. Now you are ready for assembly.









TOOLS REQUIRED

Part	Size
Wrench (included)	13,16

ADDITIONAL PARTS

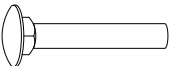
Part	Part Qty.	Usage
Shear Pins	4	Spare part (preassembled)
Clip (for auger)	4	Spare part (preassembled)
Starter Electric Cord	1	Accessory
Engine Oil	1	

ASSEMBLY PARTS

Part	Part Qty.	Description	Hardware Qty.	Hardware Reference	Tool(s) Needed
Discharge Chute	1	M10 Hexagon Lock Nut	1		16 mm wrench
		Large Washer	1		N/A
		Support Rod	1		N/A
Lower Handle	1	M8 × 16 Self-tapping Bolt	4		13 mm wrench
		Cord Clamp (preassembled)	1		N/A
Upper Handle	1	M8 × 50 Half Round Bolt	4		N/A
		Curved Washer	4		N/A
		Rotating Knob	4		N/A
		Cable Tie	3		N/A

HANDLE

1. Attach the lower handle (1-1) onto the unit body with 4 self-tapping bolts (1-2) using included tool or your own 13mm wrench (Fig. 1).

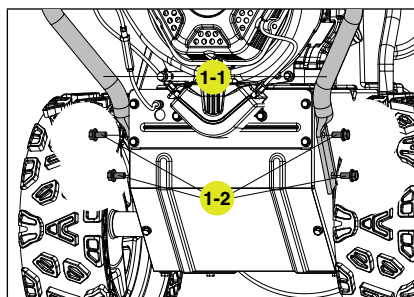

Figure 1

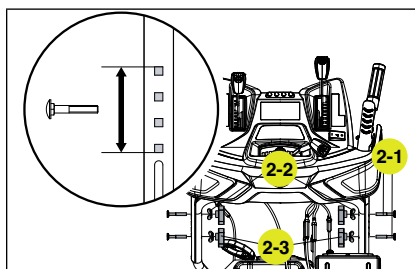

Figure 2

2. Connect the upper and lower handle with bolts (2-1), washers (2-2) and locking knobs (2-3) (Fig. 2). The top handle can adjust to 4 positions. You can come back later and adjust to a more comfortable height.

3. Remove the chute pivot assembly (3-1) from the bubble wrap and attach to the bracket on the chute (3-2). Align the round and square connector on the underside of the chute pivot assembly to the bracket. The square connector snaps in place. Then, place the entire chute (3-3) over the two posts (3-4) aligning the chute with the base (3-5). The chute will just rest on the base and rotate at this point (Fig. 3).

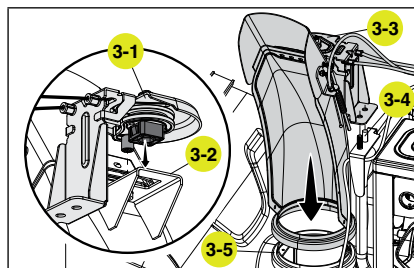

Figure 3

NOTICE: Make sure the chute pivot assembly snaps securely into the chute bracket as shown in Step 3.

4. Put the snow discharge chute cable wire form on the snow discharge support using the washer (4-1) and nut (4-2). Securely tighten the assembly (Fig. 4) using included tool or your own 16mm wrench. This will be the guide that channels all the cables over the engine from the chute area.

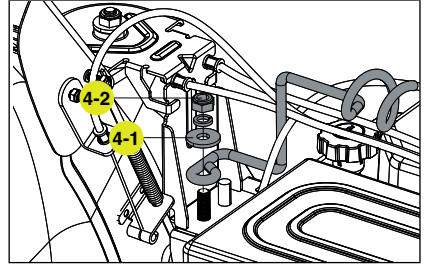

Figure 4

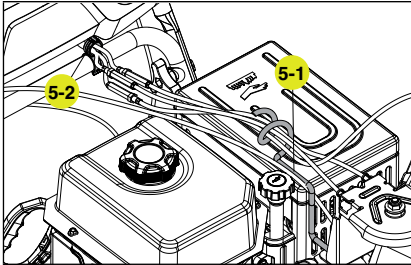

Figure 5

5. Route the cables through the support rod wire form (5-1) and cord clamp (5-2) on the lower handle. Additional cable ties are included to neaten up the cables. Keep loose before first use and adjust. When comfortable all the cabling is in proper position, tighten up the cable ties (Fig. 5).

CHECK/ADD ENGINE OIL

Capacity of engine oil: 37.2 fl. oz. (1.1 L)

Use 0W-30, but in some cases, depending on weather, 5W-30 will work. See chart for oil type recommendations.

Weather will affect engine oil and engine performance. Change the type of engine oil used based on weather conditions to suit the engine needs.

Synthetic oil may be used after the 5-hour initial break-in period. Using synthetic oil does not decrease the recommended oil change interval.

1. Check the oil with engine stopped and level.
2. Remove the oil cap/dipstick (6-1) and wipe it clean (Fig. 6).

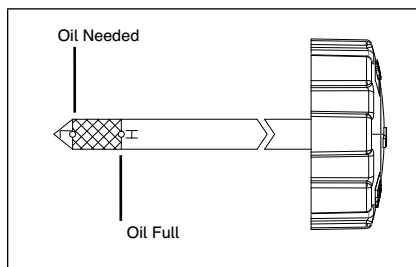

Figure 7

Recommended Engine Oil Type				
← 0W-30 / 5W-30				
°F	-20	0	20	40
°C	-28.9	-17.8	-6.7	4.4
Ambient temperature				

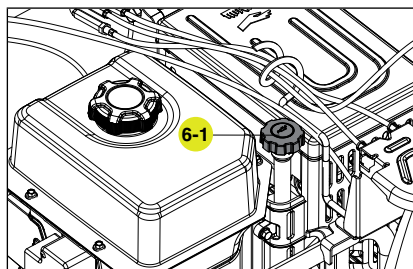

Figure 6

3. Insert the oil cap/dipstick into the oil filler neck but do not screw it in, then remove it to check the oil level.
4. If the oil level is near or below the lower limit mark on the dipstick, remove the oil cap/dipstick, and fill with the recommended oil to the upper limit mark. Do not overfill (Fig. 7).
5. Reinstall the oil cap/dipstick.

⚠ WARNING: Machine is shipped without engine oil, properly fill engine oil prior to use to prevent engine damage.

ADD FUEL**Fuel tank capacity: 1.5 gal. (5.8 L)**

Use clean, fresh, regular unleaded gasoline with a minimum octane rating of 87 and an ethanol content of less than 10% by volume.

SAFE HANDLING OF GASOLINE

To avoid severe injury or property damage use high levels of care while handling gasoline.

Gasoline is an extremely flammable substance and the vapours are explosive. Serious personal injury can occur when gasoline is spilled on yourself or your clothes, which can ignite. If you come into contact with gasoline, wash affected areas of skin and change clothing immediately.

1. Use only an approved gasoline container.
2. Extinguish all cigarettes, cigars, pipes and other sources of ignition prior to working with or near gasoline.
3. Never refuel machine within closed spaces.
4. Never remove gas cap or add fuel while the engine is hot or running.
5. Allow engine to cool at least two minutes before refueling.
6. Do not over fill fuel tank. Keep fuel level at least ½" (1.27 cm) below bottom of filler neck to provide space for fuel expansion.
7. Replace gasoline cap and tighten securely.
8. If gasoline is spilled, wipe it off the engine and equipment. Move machine to another area. Wait 5 minutes before starting the engine.

⚠ WARNING: Gasoline is highly flammable and explosive, and you can be burned or seriously injured when refueling.

- Stop engine and keep heat, sparks, and flame away.
- Refuel only outdoors.
- Gasoline is poisonous, be careful not to touch or breathe in the vapour.

model no. 060-4012-4 | contact us: 1.866.523.5218

9. Never store the machine or fuel container indoors where there is an open flame, spark or pilot light (e.g., furnace, water heater, space heater, clothes dryer etc.).
10. Allow machine to cool at least 5 minutes before storing.
11. Never fill containers inside a vehicle or on a truck or trailer bed with a plastic liner. Always place containers on the ground away from your vehicle before filling.
12. If possible, remove gas-powered equipment from the truck or trailer and refuel it on the ground. If this is not possible, then refuel such equipment on a trailer with a portable container, rather than from a gasoline dispenser nozzle.
13. Keep the nozzle in contact with the rim of the fuel tank or container opening at all times until fueling is complete. Do not use gas cans with nozzle lock-open devices.

1. Remove the fuel tank cap (8-1) (Fig. 8).

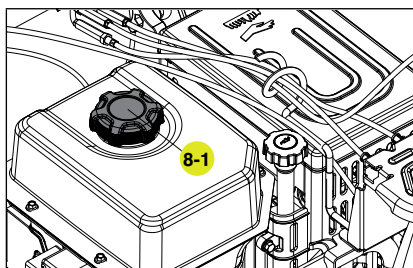

Figure 8

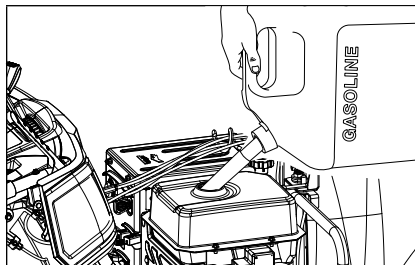

Figure 9

2. Add fuel to the bottom of the fuel level limit in the neck of the fuel tank. Do not overfill. Wipe up spilled fuel before starting the snowblower (Fig. 9).

GENERAL SAFETY

1. Read the operating and service instruction manual carefully. Be thoroughly familiar with the controls and the proper use of the equipment. Know how to stop the unit and disengage the controls quickly.
2. Never allow children under 16 years old to operate the equipment. Never allow adults to operate the equipment without proper instruction.
3. Thrown objects can cause serious injury. Keep the area of operation clear of all persons, particularly small children, and pets. Plan your snow discharge pattern to prevent throwing material toward cars, structures, roads and people.
4. Exercise caution to avoid slipping or falling, especially when operating in reverse.
5. Keep in mind that the operator or user is responsible for accidents or hazards occurring to other people or their property.
6. Never use the snowblower under the influence of alcohol or medication, or if you are tired or ill.

PREPARATION FOR USE

1. Thoroughly inspect the area where the equipment is to be used and remove all doormats, sleds, boards, wires, and other foreign objects.
2. Disengage all clutch handles before starting the motor.
3. Do not operate the equipment without wearing adequate winter garments. Wear footwear which will improve footing on slippery surfaces.
4. Adjust the auger housing height to clear gravel or crushed rock surface.
5. Never attempt to make any adjustments while the engine is running (except where specifically recommended in the manual).
6. Let engine and machine adjust to outdoor temperatures before starting to clear snow.
7. The operation of any powered machine can result in foreign objects being thrown into the eyes. Always wear safety glasses or eye shields during operation, or while performing an adjustment or repair.
8. Inspect the auger and impeller before starting to ensure that there is no ice buildup.

OPERATION

1. Do not put hands or feet near or under rotating parts. Keep clear of the discharge opening at all times.
2. Exercise extreme caution when operating on or crossing gravel drives, walks, or roads. Stay alert for hidden hazards or traffic.
3. After striking a foreign object, stop the engine, remove the spark plug, thoroughly inspect the snowblower for any damage, and repair the damage before restarting and operating the snowblower.
4. If the unit should start to vibrate abnormally, stop the engine and check immediately for the cause. Vibration indicates a mechanical problem has occurred.
5. Stop the engine whenever you leave the operating position, before unclogging the auger housing or discharge guide, and when making any repairs, adjustments, or inspections.
6. Before cleaning, inspecting or repairing any parts of the snowblower ensure the auger has stopped moving. Disconnect the spark plug wire and keep it away from the plug to prevent accidental starting.
7. Before leaving the machine unattended, disengage all control levers, stop the engine and remove the safety key.
8. Do not run the engine indoors. Exhaust fumes are dangerous.
9. Do not clear snow across the face of slopes. Exercise extreme caution when changing direction on slopes. Do not attempt to clear steep slopes.
10. Never operate the snowblower without proper guards, plates or other safety protective devices in place.
11. Never operate the snowblower near glass enclosures, automobiles, window wells, etc., without proper adjustment of the snow discharge angle. Keep children and pets away.
12. Do not overload the machine capacity by attempting to clear snow at too fast a rate.
13. Never operate the machine at high transport speeds on slippery surfaces. Use care when reversing.
14. Never direct discharge at bystanders or allow anyone in front of the unit.
15. Disengage power to the impeller when snowblower is transported or not in use.
16. Use only attachments and accessories approved by the manufacturer of snowblower.
17. Never operate the snowblower without good visibility or light. Always be sure of your footing, and keep a firm hold on the handles. Walk; never run.

18. When leaving the machine unattended, stop the engine and remove the safety key.
19. Keep all nuts, bolts and screws tight to be sure the equipment is in safe working condition.
20. Replace worn or damaged parts for safety. Use only genuine replacement parts and accessories.
21. This snowblower is not intended for use by persons (including children) with reduced physical, sensory or mental capabilities, or lack of experience and knowledge, unless they have been given supervision or instruction concerning use of the appliance by a person responsible for their safety.
22. Be careful while working on the machine or clearing a blockage in the auger or impeller to ensure that fingers and hands do not become crushed or cut.
23. Do not touch hot engine components like the muffler, muffler guard or engine block during operation of the snowblower as they will cause burns.
24. Should the unit stop discharging snow for any reason, release the controls to stop and inspect for any lodged items or damaged parts in the auger housing.

CLEARING A CLOGGED DISCHARGE CHUTE

Hand contact with the rotating impeller inside the discharge chute is the most common cause of injury associated with snowblowers. Never use your hand to clean out the discharge chute or auger assembly.

To clear the chute:

1. **SHUT THE ENGINE OFF!**
2. Wait 10 seconds to be sure the impeller blades have stopped rotating.
3. Always use a clean-out tool. **DO NOT** use your hands.

BEFORE OPERATION**CHECK THE GENERAL CONDITION:**

- Look around and underneath the engine for signs of oil or gasoline leaks.
- Remove any excessive dirt or debris, especially around the muffler and recoil starter.
- Look for signs of damage.
- Check that all shields and covers are in place, and all nuts, bolts, and screws are tightened.

CHECK THE ENGINE:

1. There is no fuel or oil in the engine. Fill with fuel and add 0W-30 prior to first use.
2. Check the fuel level (see ADD FUEL section).
3. Check the oil level (see CHECK/ADD OIL section).

 **NOTICE:** The engine can be seriously damaged without oil. Always check the oil level before using. The machine must stand on level ground when checking.

Engine key may be attached to the recoil starter grip. Please remove the key from the recoil starter grip and attach/install properly.

 **WARNING:** Never start the engine until all the above measures under assembly have been carried out.

- Never use the snowblower without first reading and understanding the instructions and all the warning and instruction stickers on the machine.
- Always use protective goggles or a visor during use, maintenance and service.

1. Make sure the engine key (safety lock out) is inserted into the keyhole.

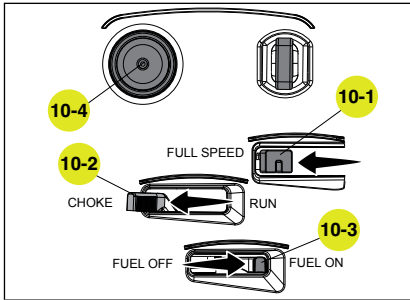

Figure 10

2. To start a cold engine: (Fig. 10).
 - 2a. Move the throttle lever (10-1) to full speed.
 - 2b. Move the choke lever (10-2) to the choke position.
 - 2c. Move the fuel shut-off lever (10-3) to the ON position.
 - 2d. Prime (10-4) 3-5 times.
 - 2e. Move the choke lever (10-2) to the run position once the engine begins to run after you pull the recoil start grip or use the electric start.

3. To start a warm engine: (Fig. 11).
 - 3a. Move the throttle lever (11-1) to full speed.
 - 3b. Move the choke lever (11-2) to the run position.
 - 3c. Move the fuel shut-off lever (11-3) to the ON position.
 - 3d. Do not prime.

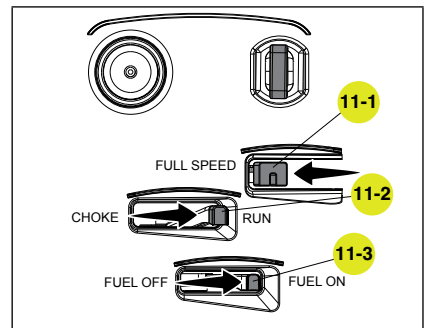

Figure 11

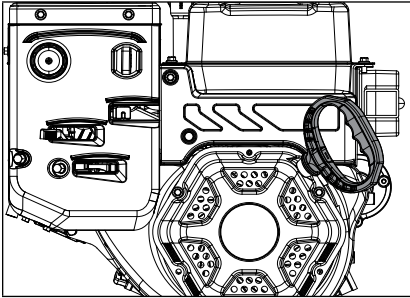

Figure 12

4. Stand back and to the right of the unit, pull the starter grip lightly until you feel resistance then pull briskly. Return the starter grip gently (Fig. 12).

5. Alternatively, for electric start, plug in the supplied electrical cord into the starter. Press the electric start button and make sure that the main supply voltage is 120 V~ 60 Hz (Fig. 13).

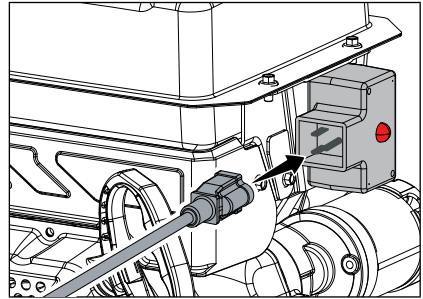

Figure 13

⚠ CAUTION: To prevent damaging the electric starter, do not run it more than 10 times at intervals of 5 seconds on, then 5 seconds off. If the engine does not start after this series of attempts, allow the starter to cool for at least 40 minutes before trying to start it again. If the engine still does not start, contact customer service centre for assistance 1.866.523.5218. Once started, disconnect the plug from the power supply and the starter.

OPERATION AT HIGH ALTITUDE

The density of air at high altitude is lower than at sea level. Engine power is reduced as the air mass and air-fuel ratio decrease. Engine power will be reduced approximately 3 ½% for every 1000' (304 m) of elevation above sea level. This is a natural trend and cannot be changed by adjusting the engine. At high altitudes increased exhaust emissions can also result due to the increased enrichment of the air fuel ratio. Other high altitude issues can include hard starting, increased fuel consumption and spark plug fouling. To alleviate high altitude issues other than the natural power loss, we can provide a high altitude carburetor main jet at an additional cost.

The part number and recommended minimum altitude for the application of the high altitude carburetor main jet is listed in the following table. In order to select the correct high altitude main jet, it is necessary to identify the carburetor model. For this purpose, a code is stamped on the side of the carburetor. Select the correct high altitude jet part number corresponding to the carburetor code found on your particular carburetor.

Carburetor Code	Main Jet	Jet Part Number	Altitude
16100-Z0S0210-R9A1	Main Jet	16161-Z151710-0000	
	High Altitude	16161-Z151510-0000	914-1828 m (3000-6000')
	High Altitude	16161-Z151910-0000	1828-2438 m (6000-8000')

STOPPING THE ENGINE

To stop the engine in an emergency or during normal operation, remove the engine key (safety lock out) from the keyhole.

model no. 060-4012-4 | contact us: 1.866.523.5218

SELF-DRIVE CONTROL LEVER.

Located on the left-side (from behind the snowblower).

When the snowblower has been put into gear, pushing this lever towards the handle engages the wheels.

Releasing the self-drive control lever causes the machine to stop moving.

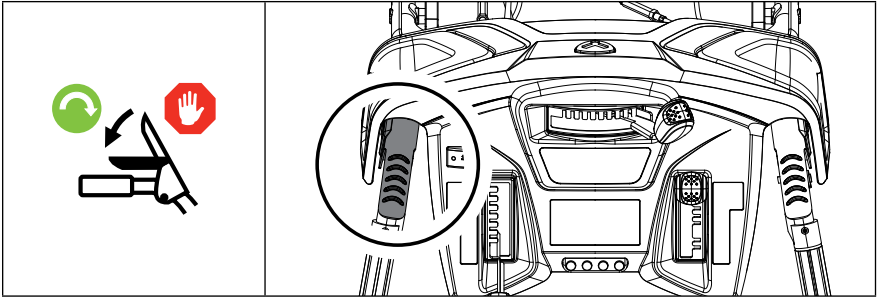

SPEED CONTROL LEVER.

Forward speeds range from slowest position 1 to fastest position 6.

Reverse speeds range from slowest position R1 to fastest position R2.

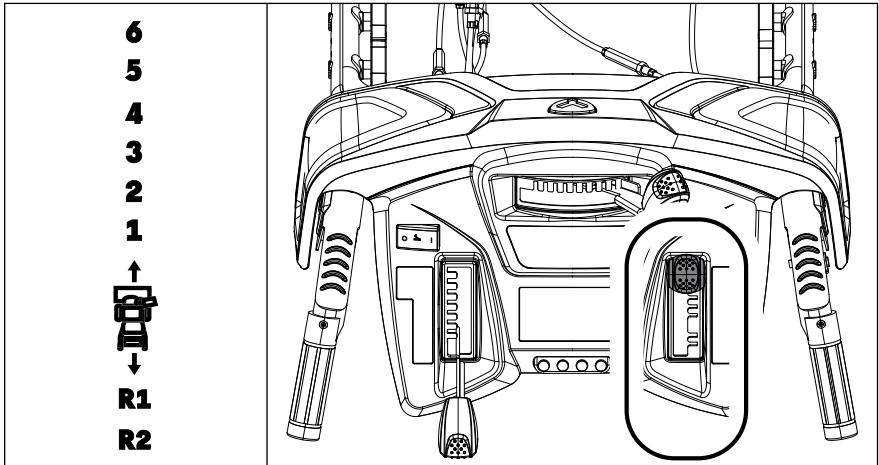

AUGER CONTROL LEVER.

Located on the right side (from behind the snowblower).

Pushing this lever towards the handle causes the auger and impeller to activate.

Releasing the auger control lever causes the auger to stop moving.

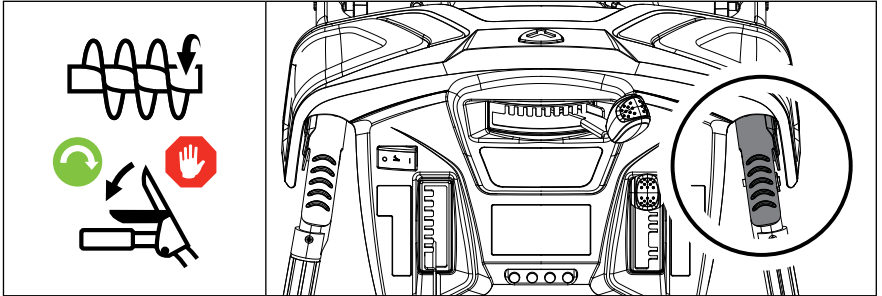

Discharge chute deflector lever controls the deflector up or down.

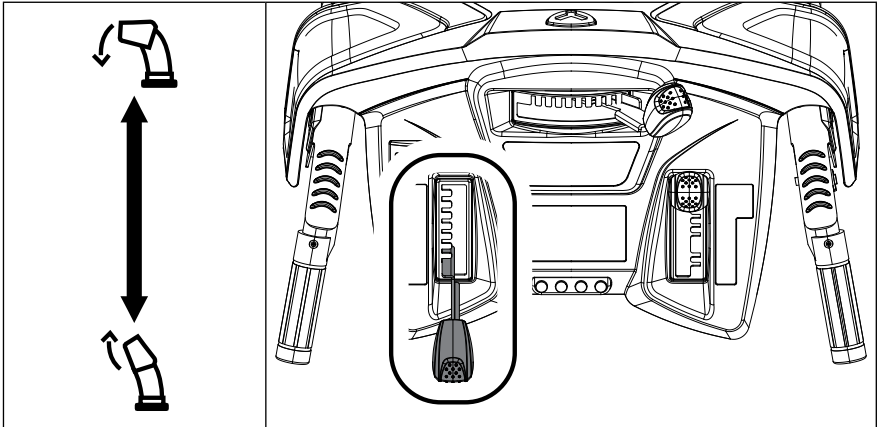

Discharge chute rotation lever controls the chute either left or right.

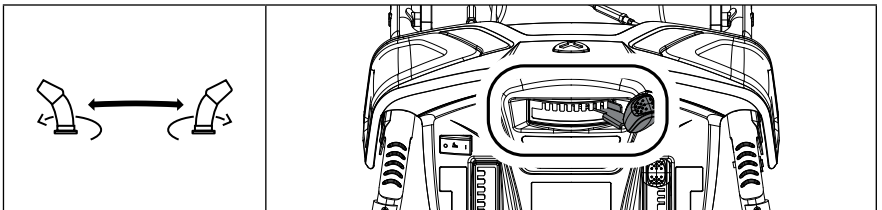

ADJUSTING THE SELF-PROPELLED DRIVE SYSTEM:

1. Release the self-drive control lever to bring the snowblower to a stop.
2. Move the speed-control lever to the gear (either forward or reverse) that you require.
3. Press the self-drive control lever to engage the drive system.



Smart Steer technology enables effortless power steering on your snowblower. Smart Steer technology is able to sense the direction your trying to turn the snowblower and engages the drive system to assist turning in the desired direction.

CLUTCH LOCK FEATURE

This snowblower offers a clutch lock feature that will enable the operator to keep the snowblower moving forward while you adjust the chute. To use the clutch lock system, follow the following steps.

- While both the drive and auger control levers are fully depressed, release the auger control lever while keeping the self-drive control lever fully depressed. The clutch lock feature will automatically keep the auger control lever engaged as long as the self-drive control lever is depressed.
- This allows the operator to keep driving the snowblower while they now use their right hand to make any adjustments to the discharge chute needed to maximize operation.
- To disengage the clutch lock feature simply release the self-drive control lever.

CHANGE DISCHARGE DIRECTION:

1. Move the discharge chute rotation lever either left or right.

CHANGE DISCHARGE HEIGHT:

1. Discharge chute deflector lever controls the deflector up or down.

ADJUSTING THE SNOW SHOES

- Tilt the snowblower auger back and place a spacer under the shave plate below the augers that is the height that you want the shave plate to ride above the ground.
- Loosen the bolts holding the skid shoes in place and slide the skid shoes down until they contacts the ground.
- Re-tighten the skid shoe bolts.

⚠ WARNING: If snow clogs the discharge chute do not try to remove it before:

- Releasing the auger control handle.
- Stopping the engine.
- Disconnecting the cable from the spark plug.

Do not put your hand inside the chute or auger. Use the chute clearing tool included with your snowblower.

LUBRICATION

No parts inside the gearbox are to be lubricated. All bearings and bushings are permanently lubricated and require no maintenance. Lubricating these parts will only result in the grease getting on to the friction wheel and disc drive plate, which could damage the rubber clad friction wheel.

LONG-TERM STORAGE

Never store the machine with gasoline in the fuel tank in a confined area with poor ventilation. Gasoline fumes could reach open flames, sparks, cigarettes, etc.

To avoid the engine freezing and problems starting the engine, leave the engine running for 5-10 minutes after your work has been completed. This will ensure all moisture will disappear that would otherwise cause starting problems.

If the machine is to be stored for a longer period than 30 days, the following procedures are recommended.

1. Mix fuel stabilizer with gasoline according to fuel stabilizer manufacturer's directions.
2. Start the engine and let it run until it stops due to lack of fuel.
3. Change the engine oil if it has not been done for 3 months.
4. Remove the spark plug and empty a little engine oil (about 1 oz {30 mL}) in the hole. Crank the engine a couple of times. Replace the spark plug.
5. Clean the whole machine thoroughly.
6. Inspect the machine for damage, and repair if necessary.
7. Apply rust protection to the metal surfaces.
8. Store the machine indoors if possible.

TRANSPORTING

If the engine has been running, allow it to cool for at least 15 minutes before loading the machine on the transport vehicle. A hot engine and exhaust system can burn you and can ignite some materials.

Keep the engine level when transporting to reduce the possibility of fuel leakage. Move the fuel valve lever to the OFF position.

REGULAR SERVICE PERIODS

Perform at every indicated month or operating hour interval, whichever comes first.

Item	Service	Each Use	Every month or 20 hrs.	Every 3 months or 50 hrs.	Every 6 months or 100 hrs.	Every year or 150 hrs.
Engine Oil	Check level	<input type="checkbox"/>				
	Change		<input type="checkbox"/>			
Spark Plug	Check/Clean				<input type="checkbox"/>	
	Replace					<input type="checkbox"/>
Spark Arrester (optional parts)	Clean				<input type="checkbox"/>	
Idle Speed	Check-adjust					<input type="checkbox"/> (1)
Valve Clearance	Check-adjust					<input type="checkbox"/> (1)
Fuel Tank and Strainer	Clean					<input type="checkbox"/> (1)
Fuel Line	Check	Every 2 years (replace if necessary) (1)				

(1) These items should be serviced by your servicing dealer unless you have the proper tools and are mechanically proficient. Refer to manual for service procedures.

⚠ WARNING: Never operate a damaged or defective snow blower.

⚠ WARNING: Improper maintenance will void your warranty.

⚠ NOTICE: For Emission control devices and systems, read and understand your responsibilities for service as stated in the Emission Control Warranty Statement of this manual.

PROBLEM	POSSIBLE CAUSE	REMEDY
Engine fails to start.	Engine flooded.	Repeat start attempts with throttle choke OFF.
	Water in fuel.	Drain tank and refill with fresh fuel.
	Other.	Check carefully the start procedure according to this manual.
Engine starts hard or runs poorly.	Spark plug issues.	Replace the spark plug.
	Fuel cap ventilation is blocked.	Clear the ventilation or replace cap.
Auger does not rotate.	Foreign material caught in system.	Clean.
	Auger drive belt slipping.	Adjust the belt and wire.
	Auger drive belt broken.	Replace the belt.
Auger does not stop when the lever is released.	Auger drive belt is out of adjustment.	Adjust the belt.
	Auger drive guide is out of adjustment.	Adjust the guide.
Snowblower veers to one side.	Tire pressure not equal.	Adjust the tire pressure.
	Wheel spring lock pin is inserted on one side.	Check the wheel locks.
	Shoes are mounted unevenly.	Adjust shoes.
	Scraper blade uneven.	Adjust scraper blade and shoes.
Snowblower does not drive.	Auger drive belt worn/broken.	Replace traction drive belt.
	Friction disc worn out.	Repair or replace friction disc.

4-YEAR LIMITED WARRANTY

For Four YEARS from the date of purchase within Canada, YARDWORKS CANADA will, at its option, repair or replace for the original purchaser, free of charge, any part or parts found to be defective in material or workmanship.

THIS WARRANTY DOES NOT COVER:

1. Any part that has become inoperative due to misuse, commercial use, abuse, neglect, accident, improper maintenance, or alteration;
2. The unit, if it has not been operated and/or maintained in accordance with the owner's manual;
3. Normal wear parts like belts, skid shoes and shave plates except as noted below;
4. Routine maintenance items such as oil, spark plug, fuel line; or
5. Normal deterioration of the exterior finish due to use or exposure.

FULL 270-DAY WARRANTY ON NORMAL WEAR PARTS:

Normal wear parts are defined as wheels, tires, belts, drive disc, skid shoes and shave plate. These parts are warranted to the original purchaser to be free from defects in material and workmanship for a period of two hundred seventy (270) days from the date of retail purchase.

HOW TO OBTAIN SERVICE:

Warranty service is available by calling the toll-free helpline at 1.866.523.5218.

The factory will not accept the return of a complete unit unless prior written permission has been extended by YARDWORKS CANADA.

TRANSPORTATION CHARGES:

Transportation charges for the movement of the generator or accessories are the responsibility of the purchaser. The purchaser must pay transportation charges for any part submitted for replacement under this warranty unless such return is requested in writing by YARDWORKS CANADA.

OTHER WARRANTIES:

All other warranties, express or implied, including any implied warranty of merchantability is limited in its duration to that set forth in this express limited warranty. The provisions as set forth in this warranty provide the sole and exclusive remedy of YARDWORKS CANADA obligations arising from the sale of its products.



model no. 060-4012-4 | contact us: 1.866.523.5218

ADDITIONAL LIMITATIONS

This warranty applies only to the original purchaser and may not be transferred. Neither the retailer nor the manufacturer shall be liable for any other expense, loss or damage, including, without limitation, any indirect, incidental, consequential or exemplary damages arising in connection with the sale, use or inability to use this product.

NOTICE TO CONSUMER

This warranty gives you specific legal rights, and you may have other rights, which may vary from province to province. The provisions contained in this warranty are not intended to limit, modify, take away from, disclaim or exclude any statutory warranties set forth in any applicable provincial or federal legislation.

Made in China

Imported by
Trileaf Distribution Toronto, Canada M4S 2B8

WARRANTY

YARDWORKS CANADA will not be liable for incidental or consequential loss or damage.

**CHAMPION POWER EQUIPMENT, INC. (CPE)
AND THE UNITED STATES ENVIRONMENTAL PROTECTION AGENCY (U.S. EPA)
EMISSION CONTROL SYSTEM WARRANTY**

Your Champion Power Equipment (CPE) engine complies with U.S. EPA emissions regulations.

YOUR WARRANTY RIGHTS AND OBLIGATIONS:

The US EPA and CPE are pleased to explain the Federal Emission Control Systems Warranty on your 2020 small off-road engine (SORE) and engine powered equipment. New engines and equipment must be designed, built and equipped, at the time of sale, to meet U.S. EPA regulations for small off-road engines (SORE). CPE warrants the emission control system on your small off-road engine (SORE) and equipment for the period of time listed below, provided there has been no abuse, neglect, unapproved modification, or improper maintenance of your equipment.

Your emission control system may include parts such as the carburetor, fuel-injection system, the ignition system, catalytic converter and fuel lines. Also included may be hoses, belts, connectors and other emission related assemblies. Where a warrantable condition exists, CPE will repair your small off-road engine (SORE) at no cost to you including diagnosis, parts and labor.

MANUFACTURER'S EMISSION CONTROL SYSTEM WARRANTY COVERAGE:

This emission control system is warranted for two years, subject to provisions set forth below. If, during the warranty period, an emission related part on your engine is defective in materials or workmanship, the part will be repaired or replaced by CPE.

OWNER WARRANTY RESPONSIBILITIES:

As the small off-road engine (SORE) owner, you are responsible for the performance of the required maintenance listed in your Owner's Manual. CPE recommends that you retain all your receipts covering maintenance on your small off-road engine, but CPE cannot deny warranty solely for the lack of receipts or for your failure to ensure the performance of all scheduled maintenance.

As the small off-road engine (SORE) owner, you should however be aware that CPE may deny you warranty coverage if your small, off-road engine (SORE) or a part has failed due to abuse, neglect, improper maintenance or unapproved modifications.

You are responsible for presenting your small off-road engine (SORE) to an Authorized CPE service outlet or alternate service outlet as described in (3)(f.) below, CPE dealer or CPE, Santa Fe Springs, Ca. as soon as a problem exists. The warranty repairs should be completed in a reasonable amount of time, not to exceed 30 days.

If you have any questions regarding your warranty rights and responsibilities, you should contact:

Champion Power Equipment, Inc.
Customer Service
12039 Smith Ave.
Santa Fe Springs, CA 90670
1-877-338-0999
tech@championpowerequipment.com

EMISSION CONTROL SYSTEM WARRANTY

The following are specific provisions relative to your Emission Control System (ECS) Warranty Coverage.

- 1. APPLICABILITY:** This warranty shall apply to 1997 and later model year small off-road engines (SORE). The ECS Warranty Period shall begin on the date the new engine or equipment is delivered to its original, end-use purchaser, and shall continue for 24 consecutive months thereafter.
- 2. GENERAL EMISSIONS WARRANTY COVERAGE**

CPE warrants to the original, end-use purchaser of the new engine or equipment and to each subsequent purchaser that each of its small off-road engines (SORE) is:

 - 2a. Designed, built and equipped so as to conform to U.S. EPA emissions standards for spark-ignited engines at or below 19 kilowatts.
 - 2b. Free from defects in materials and workmanship that cause the failure of a warranted part to be identical in all material respects to the part as described in the engine manufacturer's application for certification for a period of two years.
- 3. THE WARRANTY ON EMISSION-RELATED PARTS WILL BE INTERPRETED AS FOLLOWS:**
 - 3a. Any warranted part that is not scheduled for replacement as required maintenance in the Owners Manual shall be warranted for the ECS Warranty Period. If any such part fails during the ECS Warranty Period, it shall be repaired or replaced by CPE according to Subsection "d" below. Any such part repaired or replaced under the ECS Warranty shall be warranted for any remainder of the ECS Warranty Period.
 - 3b. Any warranted, emissions-related part which is scheduled only for regular inspection as specified in the Owners Manual shall be warranted for the ECS Warranty Period. A statement in such written instructions to the effect of "repair or replace as necessary", shall not reduce the ECS Warranty Period. Any such part repaired or replaced under the ECS Warranty shall be warranted for the remainder of the ECS Warranty Period.
 - 3c. Any warranted, emissions-related part which is scheduled for replacement as required maintenance in the Owner's Manual shall be warranted for the period of time prior to the first scheduled replacement point for that part. If the part fails prior to the first scheduled replacement, the part shall be repaired or replaced by CPE according to Subsection "d" below. Any such emissions-related part repaired or replaced under the ECS Warranty, shall be warranted for the remainder of the ECS Warranty Period prior to the first scheduled replacement point for such emissions-related part.
 - 3d. Repair or replacement of any warranted, emissions-related part under this ECS Warranty shall be performed at no charge to the owner at a CPE Authorized Service Outlet.
 - 3e. The owner shall not be charged for diagnostic labor which leads to the determination that a part covered by the ECS Warranty is in fact defective, provided that such diagnostic work is performed at a CPE Authorized Service Outlet.
 - 3f. CPE shall pay for covered emissions warranty repairs at non-authorized service outlets under the following circumstances:
 - i. The service is required in a population center with a population over 100,000 according to U.S. Census 2000 without a CPE Authorized Service Outlet AND
 - ii. The service is required more than 100 miles from a CPE Authorized Service Outlet. The 100 mile limitation does not apply in the following states: Alaska, Arizona, Colorado, Hawaii, Idaho, Montana, Nebraska, Nevada, New Mexico, Oregon, Texas, Utah and Wyoming.
 - 3g. CPE shall be liable for damages to other original engine components or approved modifications proximately caused by a failure under warranty of an emission-related part covered by the ECS Warranty.
 - 3h. Throughout the ECS Warranty Period, CPE shall maintain a supply of warranted emission-related parts sufficient to meet the expected demand for such emission-related parts.
 - 3i. Any CPE Authorized and approved emission-related replacement part may be used in the performance of any ECS Warranty maintenance or repair and will be provided without charge to the owner. Such use shall not reduce CPE's warranty obligation.
 - 3j. Unapproved add-on or modified parts may not be used to modify or repair a CPE engine. Such use voids this ECS Warranty and shall be sufficient grounds for disallowing an ECS Warranty claim. CPE shall not be liable hereunder for failures of any warranted parts of a CPE engine caused by the use of such an unapproved add-on or modified part.

EMISSION-RELATED PARTS INCLUDE THE FOLLOWING: (using those portions of the list applicable to the engine)

Systems covered by this warranty	Parts Description
Fuel Metering System	Fuel regulator, Carburetor and internal parts
Air Induction System	Air cleaner, Intake manifold
Ignition System	Spark plug and parts, Magneto ignition system
Exhaust System	Exhaust manifold, catalytic converter
Miscellaneous Parts	Tubing, Fittings, Seals, Gaskets, and Clamps associated with these listed systems.
Evaporative Emissions	Fuel Tank, Fuel Cap, Fuel Lines (for liquid fuel and fuel vapors), Fuel Line Fittings, Clamps, Pressure Relief Valves, Control Valves, Control Solenoids, Electronic Controls, Vacuum Control Diaphragms, Control Cables, Control Linkages, Purge Valves, Gaskets, Liquid/Vapor Separator, Carbon Canister, Canister Mounting Brackets, Carburetor Purge Port Connector

TO OBTAIN WARRANTY SERVICE:

You must take your CPE engine or the product on which it is installed, along with your warranty registration card or other proof of original purchase date, at your expense, to any Champion Power Equipment dealer who is authorized by Champion Power Equipment, Inc. to sell and service that CPE product during his normal business hours. Alternate service locations defined in Section (3)(f.) above must be approved by CPE prior to service. Claims for repair or adjustment found to be caused solely by defects in material or workmanship will not be denied because the engine was not properly maintained and used.

If you have any questions regarding your warranty rights and responsibilities, or to obtain warranty service, please write or call Customer Service at Champion Power Equipment, Inc.

Champion Power Equipment, Inc.
12039 Smith Ave.
Santa Fe Springs, CA 90670
1-877-338-0999
Attn.: Customer Service
tech@championpowerequipment.com