

Replacing the Carburetor

This bulletin covers the following Champion Power Equipment products:

(Note: Read instructions completely, and wear proper safety gear and safety glasses before performing service):

- Generator model numbers: 41332 and 41532.

DANGER

Fuel and fuel vapors are highly flammable and extremely explosive. Fire or explosion can cause severe burns or death. Unintentional start-up can result in entanglement, traumatic amputation or laceration.

When servicing:

- Loosen the cap slowly to relieve pressure in the tank.
- Always keep fuel away from sparks, open flames, pilot lights, heat and other sources of ignition.
- DO NOT light or smoke cigarettes.
- Wipe up any spilled fuel immediately.
- Allow fuel residue to evaporate fully before attempting to service or start the engine.
- Make certain that the product is resting firmly on level ground.
- DO NOT tip the product or allow fuel or oil to spill.
- Make certain that the fuel shut-off valve is in the OFF position.

WARNING

Sparks can result in fire or electrical shock.

When servicing:

- Disconnect the spark plug wire and place it where it cannot contact the spark plug.
- DO NOT check for spark with the plug removed.
- Use only approved spark plug testers.

Part locations:

- 1) Carburetor
- 2) Fuel Valve
- 3) Air Filter Cover Assembly
- 4) Governor Rod

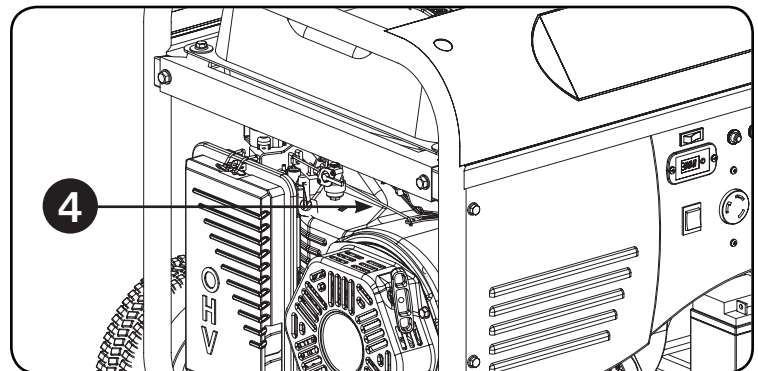
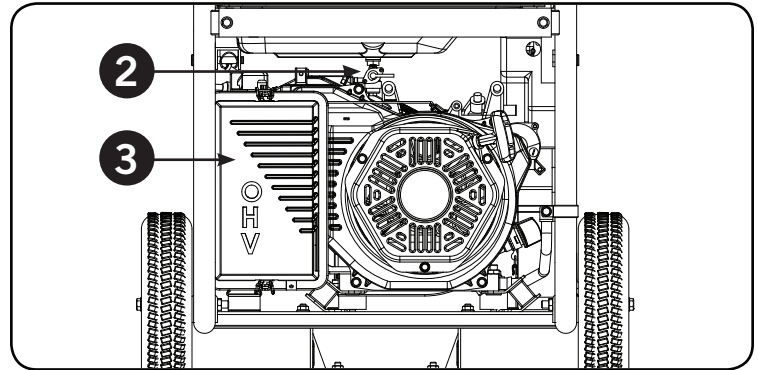
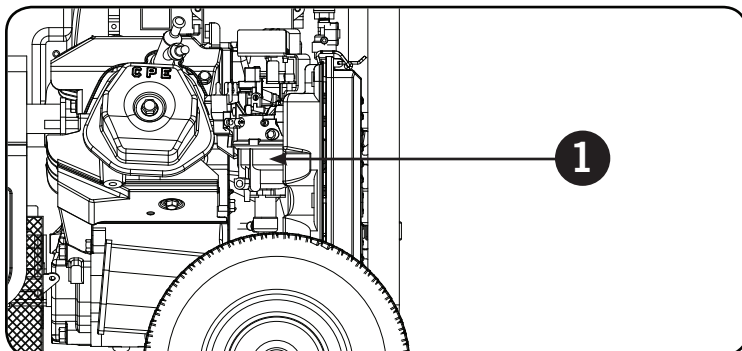

- 1) Turn the Fuel Valve to the “OFF” (horizontal) position. (A) Make sure the fuel supply is off before performing any maintenance.
- 2) Disconnect the Negative (black) cable from the battery.
- 3) Disconnect the Fuel Line from the Fuel Valve. (B)

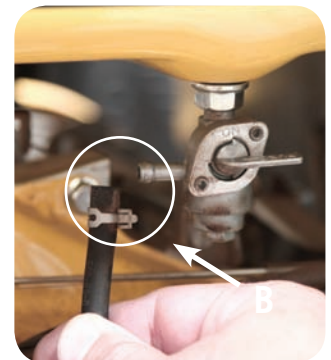
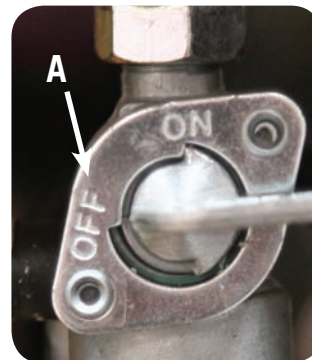

Note: Even with the Fuel Valve in the “OFF” position, some fuel may still spill out. Make sure to wipe up any spilled fuel.

Replacing the Carburetor

- 4) Using a 10 mm wrench or socket, or screwdriver (flat head or phillips), remove the float bowl drain bolt. Be sure to have a "catch can" or rag, in case any fuel was left in the bowl. (C)

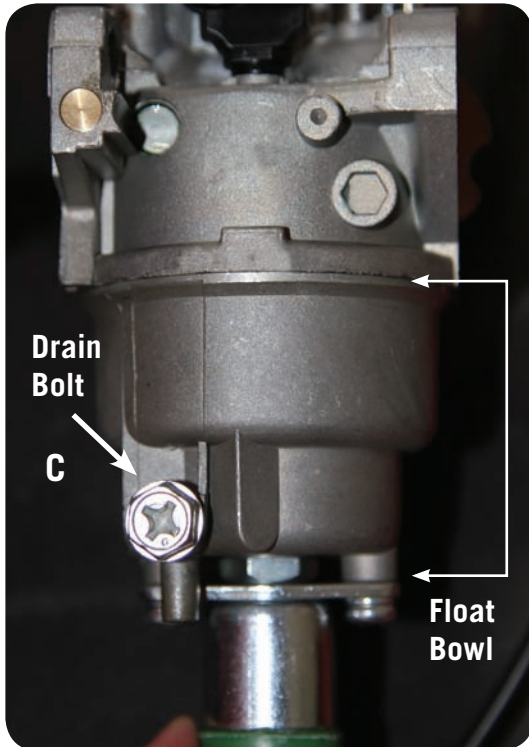

- 5) Unsnap the metal clips (top and bottom of air filter cover), and remove the cover from the air filter housing.
- 6) Remove the foam air filter from within the air filter housing.

Note: Oil, liquid and other debris may become dislodged and spill out when removing the foam piece and disconnecting the air filter housing from the generator.

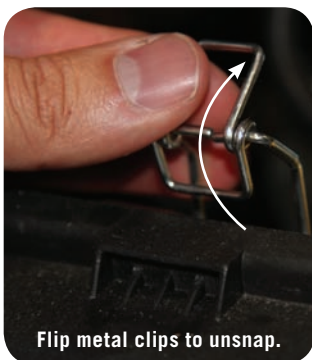

- 7) Using an 8 mm wrench or socket, remove all six (6) M5 Nuts on the front side of the air filter housing. (D)
- 8) Using your hands, gently pull both the breather tube (top) and the fuel vapor hose (bottom) from the air filter housing. (E)

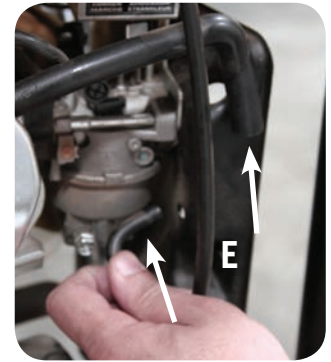

- 9) Using a 10 mm wrench or socket, remove the M6 Nut on the lower back side of the air filter housing. (F)
- 10) Disconnect both the Fuel Cut Solenoid Wires (green) and the choke actuator wire connector (white). (G) The wires are located on the yellow engine shroud, with the connection points just behind the electric panel.

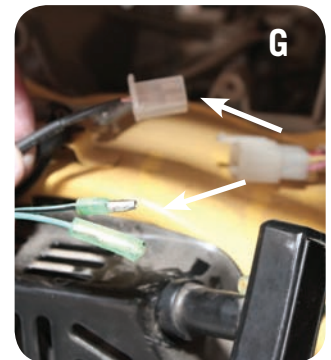
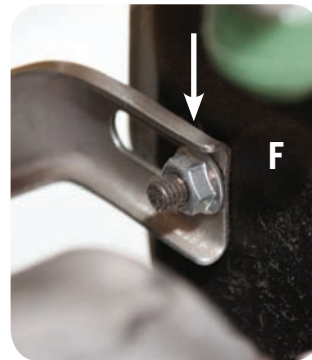

Replacing the Carburetor

- 11) Using a screwdriver, gently pry the wire clips out of the generator. There is wire clip on each side of the fuel valve on the yellow engine shroud. (H)

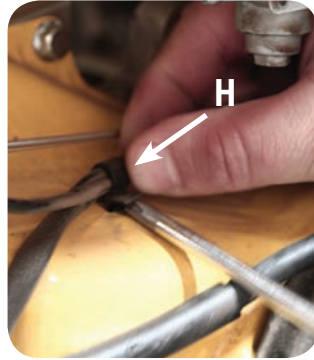
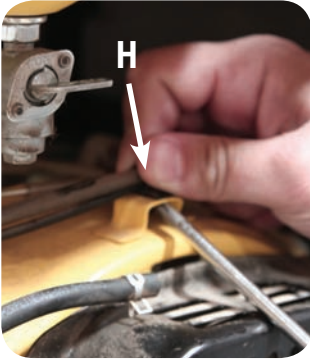

Note: The wire clips will “pop” out, using minimal force.

- 12) Using a 10 mm wrench or socket, remove the two (2) M6 Nuts on the front side of the air filter housing. (I)

- 13) Take the complete air filter housing off of the generator. (J)



- 14) Using your fingers, gently pull and disconnect the throttle spring from the black pivot arm on the carburetor. (K)

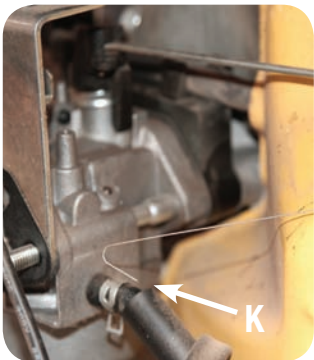
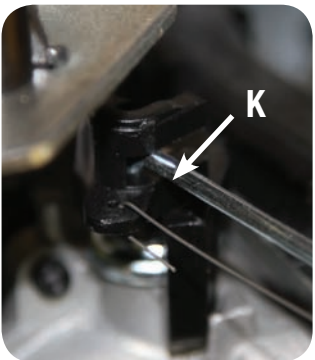

- 15) Using your hands, gently pull the carburetor outwards away from the engine, half-way off of the mounting studs, so that you can position the carburetor for removing the governor rod. (L)

- 16) Using your fingers, rotate the black pivot arm clockwise on the carburetor, and remove the governor rod. (M)

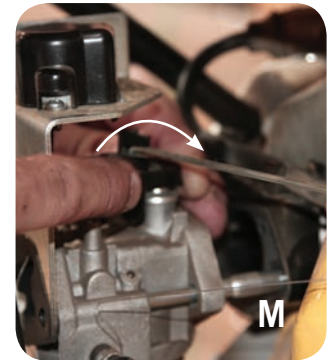
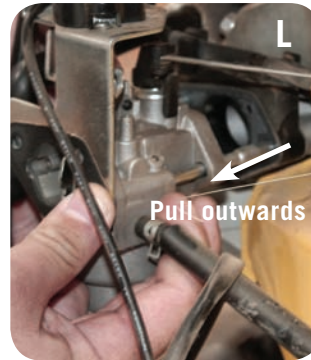

Note: The black pivot arm is designed to lock and keep the governor rod in place, so it must be rotated clockwise (1) in order to remove the governor rod (2). (see below)

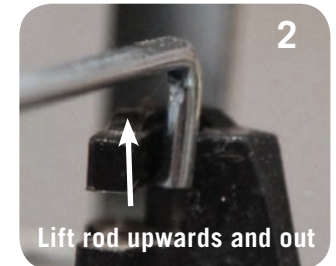
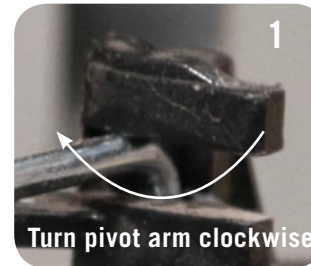

- 17) Once the throttle spring and governor rod have both been disconnected, gently slide the carburetor completely off the mounting studs, taking with it the insulator gasket. (N)



- 18) Once the carburetor and gasket have been removed from the mounting studs, make sure insulator surface is clean. (O)

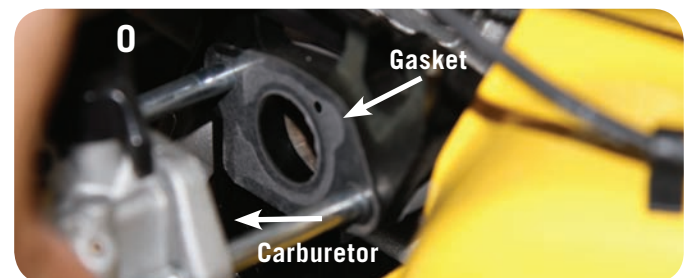

Note: If the insulator gasket comes off, we have included an extra one if needed.

Replacing the Carburetor

- 19) While holding the replacement carburetor assembly together, cut the zip ties, making sure nothing comes loose or apart from the assembly.
- 20) Using your hands, gently slide the new carburetor inwards half-way onto the mounting studs, so that you can reattach the governor rod and throttle spring. (P)
- 21) Reattach the governor rod and throttle spring. The black pivot arm needs to be rotated counter clockwise to hold the governor rod in place. (Q).

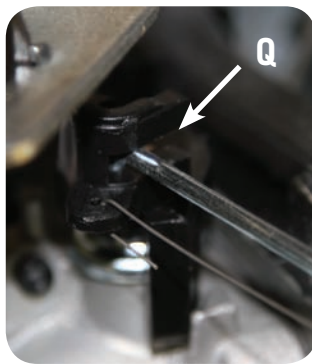

- 22) **ONLY WHEN** the governor rod and throttle spring are re-connected, should you remove the white plastic dowel pin that is pre-installed to stabilize the assembly. Keeping inward pressure on the assembly while removing the dowel pin. (R)
- 23) Once the white dowel pin has been removed, the steel stepper plate may move, causing the choke dampener spring to become loose and fall out. If this occurs, see additional steps at the end of this bulletin to reconnect the spring with the assembly.

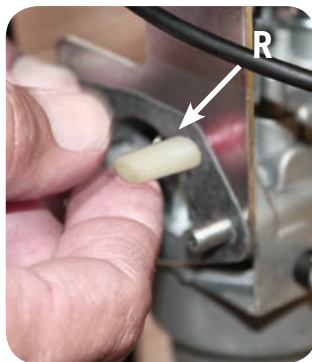
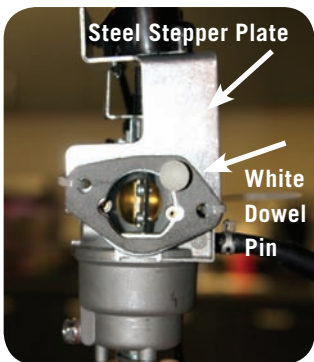

- 24) Reverse steps 1-11, reconnecting and reattaching the air filter housing, wires, fuel valve hose, and negative battery lead.
- 25) Once all the parts have been reconnected, check all parts and connections for leaks.

- 26) Turn the fuel valve to the "ON" position. Start the Engine.

Note: Make certain that the gas cap, air filter, spark plug, fuel lines and exhaust system are properly in place before starting the generator.

- 27) Run the generator for a few minutes (**with NO loads attached**), to verify a stable running condition.

Note: Use your generator's Intelligauge™ or Voltmeter to read the output of volts produced. The range of volts should be between 245 and 255, for a stable running condition.

- 28) Once a stable condition has been verified, shut off the fuel valve and run the engine until fuel starvation has shut it off. Once this has happened, turn the engine and battery switch to the off position.

Note: It is always advisable to shut off the fuel valve and run until fuel starvation has shut off the engine. Leaving the fuel line and carburetor free of fuel is recommended.

If you have any questions, please contact us at:

Champion Power Equipment, Inc.

Customer Service

12039 Smith Ave.

Santa Fe Springs, CA 90670

www.championpowerequipment.com

Technical Service

Mon – Fri 8:30 AM – 5:00 PM (PST/PDT)

Toll Free: 1-877-338-0999

tech@championpowerequipment.com

Replacing the Carburetor

What to do if the Choke Dampener Spring becomes dislodged from the assembly.

- 1) If the choke dampener spring becomes dislodged from the carburetor assembly, remove the assembly from the mounting studs, so that the spring can be reinstalled.
- 2) Disassemble the steel stepper motor plate from the assembly, so that the choke coupler (black piece) is free from the assembly. (A)
- 3) Reattach the choke dampener spring to the choke coupler. (B)

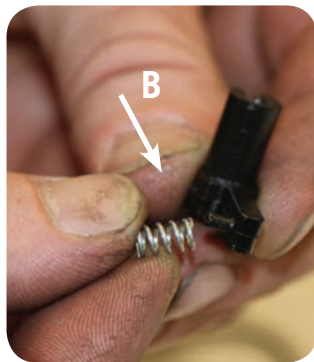
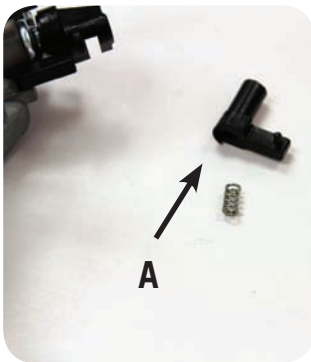

- 4) Once the spring is reattached to the choke coupler, reinsert the choke coupler back into the choke arm. (C)

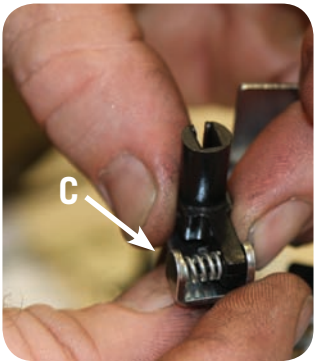
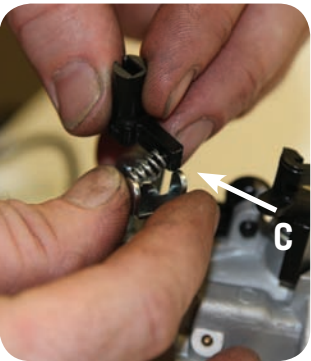

- 5) Match the stepper shaft (gold piece) up with the groove in the choke stepper motor (black piece). These pieces must be matched up in order for the steel stepper plate to fit back on/with the assembly. (D)

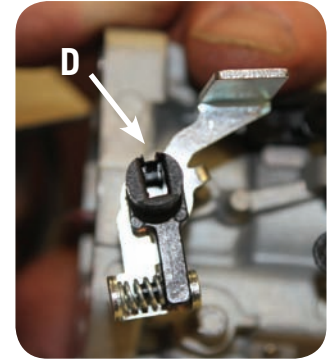
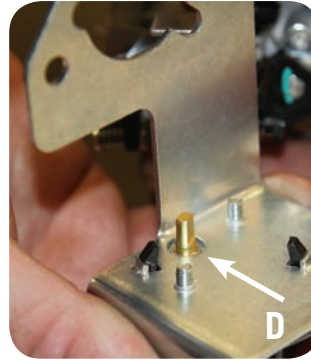

- 6) Once these two pieces have matched up, carefully reattach the steel stepper arm with the assembly. (E)

