

CHAMPION

POWER EQUIPMENT™

40049
Rev 40049-20080609



Owner's Manual and Operating Instructions



4000 Peak Watts / 3500 Running Watts

PORTABLE GENERATOR

Table of Contents

Introduction	1	Storage	15
Portable Power Generator	1	Engine Storage	15
Accessories	1	Generator Storage	15
This Booklet	1	Specifications	16
Manual Conventions	2	Engine Specifications	16
Safety Rules	3	Generator Specifications	16
Controls and Features	5	Fuel	16
Generator	5	Oil	16
Power Panel	6	Spark Plugs	16
Parts Included	7	Valve Clearance	16
Assembly	8	Parts Diagram	17
Remove the Generator from the Shipping		Parts List	18
Carton	8	Wiring Diagram	20
Install the Spark Arrester	8	Troubleshooting	21
Add Engine Oil	8	Warranty	22
Add Fuel	9	Warranty Qualifications	22
Grounding	9	Repair/Replacement Warranty	22
Operation	10	Do not return the unit to the place of	
Generator Location	10	purchase	22
Grounding	10	Warranty Exclusions	22
Surge Protection	10	Normal Wear	22
Starting the Engine	10	Installation, Use and Maintenance	22
Connecting Electrical Loads	10	Other Exclusions	22
Stopping the Engine	10	Limits of Implied Warranty and	
Do Not Overload Generator	11	Consequential Damage	22
Capacity	11	Contact Information	23
Power Management	11	Address	23
Wattage Reference Chart	12	Customer Service	23
Maintenance	13	Technical Service	23
Engine Maintenance	13	Notes	27
Oil	13		
Spark Plugs	13		
Air Filter	13		
Spark Arrester	14		
Cleaning	14		
Adjustments	14		
Maintenance Schedule	14		
Generator Maintenance	14		

Introduction

Congratulations on your purchase of a Champion Power Equipment generator. CPE designs and builds generators to strict specifications. With proper use and maintenance, this generator will bring years of satisfying service.

Portable Power Generator

This unit is a gasoline engine driven, alternating current (AC) generator. It is designed to supply electrical power for lighting, appliances, tools and similar equipment.

Accessories

Champion Power Equipment manufactures and sells accessories designed to help you get the most from your purchase. To find out more about our covers, power cables and storm kits, please visit our web site at

www.championpowerequipment.com

This Booklet

Every effort has been made to ensure the accuracy and completeness of the information in this manual. We reserve the right to change, alter and/or improve the product and this document at any time without prior notice.

Record the model and serial numbers as well as date and place of purchase for future reference. Have this information available when ordering parts and when making technical or warranty inquiries.

Champion Power Equipment Support
1-877-338-0999
Model Number
40049
Serial Number
Date of Purchase
Purchase Location

Manual Conventions

Manual Conventions

This manual uses the following symbols to help differentiate between different kinds of information. The safety symbol is used with a key word to alert you to potential hazards in operating and owning power equipment.

Follow all safety messages to avoid or reduce the risk of serious injury or death.

DANGER

DANGER indicates an imminently hazardous situation which, if not avoided, *will* result in death or serious injury.

WARNING

WARNING indicates a potentially hazardous situation which, if not avoided, *could* result in death or serious injury.

CAUTION

CAUTION indicates a potentially hazardous situation which, if not avoided, *may* result in minor or moderate injury.

CAUTION

CAUTION used without the safety alert symbol indicates a potentially hazardous situation which, if not avoided, *may* result in property damage.

NOTE

If you have questions regarding your generator, we can help. Please call our help line at 1-877-338-0999.

Safety Rules

WARNING

Read this manual thoroughly before operating your generator. Failure to follow instructions could result in serious injury or death.

WARNING

The engine exhaust from this product contains chemicals known to the state of California to cause cancer, birth defects, or other reproductive harm.

DANGER

Generator exhaust contains carbon monoxide, a colorless, odorless, poison gas. Breathing carbon monoxide will cause nausea, dizziness, fainting or death.

Operate generator outdoors only in a well ventilated area.
DO NOT operate the generator inside any building, enclosure or compartment, including the generator compartment of a recreational vehicle.
DO NOT allow exhaust fumes to enter a confined area through windows, doors, vents or other openings.

DANGER

Rotating parts can entangle hands, feet, hair, clothing and/or accessories.

Traumatic amputation or severe laceration can result.

Keep hands and feet away from rotating parts.
Tie up long hair and remove jewelry.
Operate equipment with guards in place.
DO NOT wear loose-fitting clothing, dangling drawstrings or items that could become caught.

DANGER

Generator produces powerful voltage.

DO NOT touch bare wires or receptacles.
DO NOT use electrical cords that are worn, damaged or frayed.
DO NOT operate generator in wet weather.
DO NOT allow children or unqualified persons to operate or service the generator.
Use a ground fault circuit interrupter (GFCI) in damp areas and areas containing conductive material such as metal decking.
Use approved transfer equipment to isolate generator from your electric utility and Notify your utility company before connecting your generator to your power system.

WARNING

Sparks can result in fire or electrical shock.

When servicing the generator:

Disconnect the spark plug wire and place it where it cannot contact the plug.
DO NOT check for spark with the plug removed.
Use only approved spark plug testers.

WARNING

Running engines produce heat.
Severe burns can occur on contact.
Combustible material can catch fire on contact.

DO NOT touch hot surfaces.
Avoid contact with hot exhaust gases.
Allow equipment to cool before touching.
Maintain at least three feet of clearance on all sides to ensure adequate cooling.
Maintain at least five feet of clearance from combustible materials.

Safety Rules

DANGER

Fuel and fuel vapors are highly flammable and extremely explosive.

Fire or explosion can cause severe burns or death.

Unintentional startup can result in entanglement, traumatic amputation or laceration.

When adding or removing fuel

Turn the generator off and let it cool for at least two minutes before removing the fuel cap. Loosen the cap slowly to relieve pressure in the tank.

Only fill or drain fuel outdoors in a well-ventilated area.

DO NOT overfill the fuel tank.

Always keep fuel away from sparks, open flames, pilot lights, heat and other sources of ignition.

DO NOT light or smoke cigarettes.

When starting the generator

DO NOT attempt to start a damaged generator. Make certain that the gas cap, air filter, spark plug, fuel lines and exhaust system are properly in place.

Allow spilled fuel to evaporate fully before attempting to start the engine.

Make certain that the generator is resting firmly on level ground.

When operating the generator:

DO NOT move or tip the generator during operation.

DO NOT tip the generator or allow fuel or oil to spill.

When transporting or servicing the generator:

Make certain that the fuel shutoff valve is in the off position and the fuel tank is empty.

Disconnect the spark plug wire.

When storing the generator:

Store away from sparks, open flames, pilot lights, heat and other sources of ignition.

WARNING

Rapid retraction of the starter cord will pull hand and arm towards the engine faster than you can let go.

Unintentional startup can result in entanglement, traumatic amputation or laceration.

Broken bones, fractures, bruises or sprains could result.

When starting engine, pull the starter cord slowly until resistance is felt and then pull rapidly to avoid kickback.

DO NOT start or stop the engine with electrical devices plugged in.

CAUTION

Exceeding the generator's running capacity can damage the generator and/or electrical devices connected to it

DO NOT overload the generator.

Start the generator and allow the engine to stabilize before connecting electrical loads.

Connect electrical equipment in the off position, and then turn them on for operation.

Turn electrical equipment off and disconnect before stopping the generator.

DO NOT tamper with the factory set governor speed.

DO NOT modify the generator in any way.

CAUTION

Improper treatment or use of the generator can damage it, shorten its life and void your warranty.

Use the generator only for intended uses.

Operate only on level surfaces.

DO NOT expose generator to excessive moisture, dust, or dirt.

DO NOT allow any material to block the cooling slots.

If connected devices overheat, turn them off and disconnect them from the generator.

DO NOT use the generator if:

Electrical output is lost

Equipment sparks, smokes or emits flames

Equipment vibrates excessively

Controls and Features

Read this owner's manual before operating your generator. Familiarize yourself with the location and function of the controls and features. Save this manual for future reference.

Generator

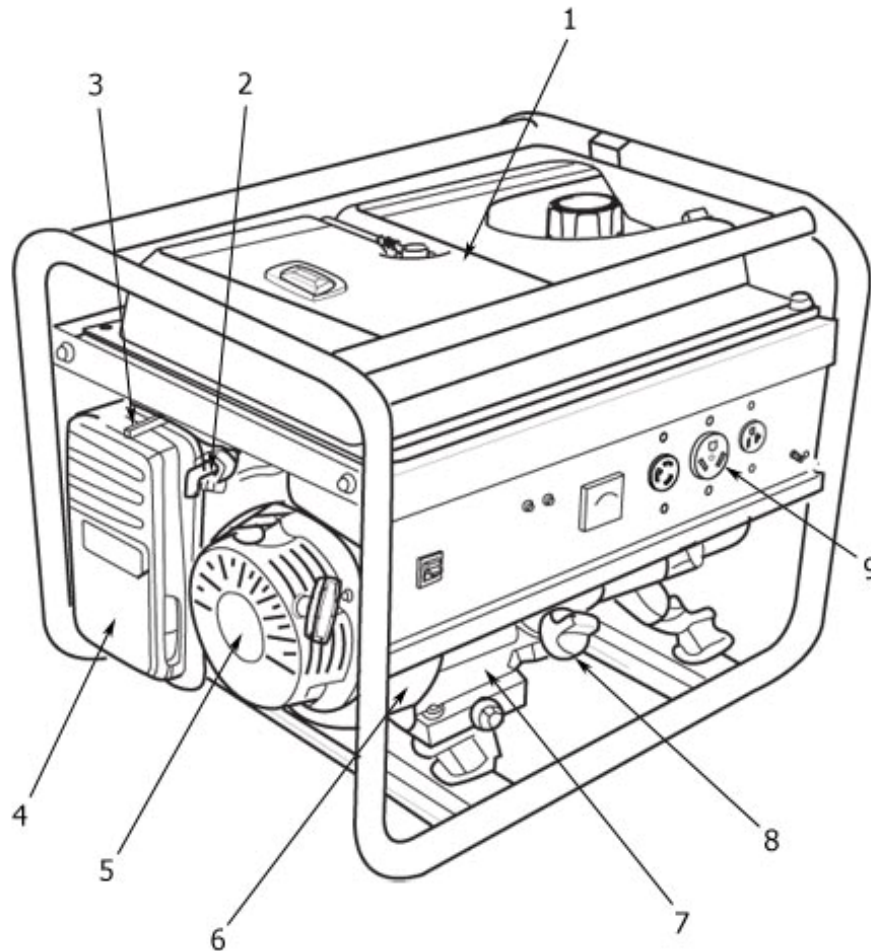

(1) Fuel Tank – 3.8 gallon capacity fuel tank.

(2) Fuel Valve – Turn this valve to the “On” position to supply fuel to the engine.

(3) Choke – Used to start the engine

(4) Air Cleaner – Protects the engine by filtering dust and debris from the intake air.

(5) Recoil Starter – Used to start the engine

(6) Serial Number – Please have this number available when calling for assistance.

(7) Low Oil Sensor – Senses the level of oil in the crankcase and shuts the engine down if the level falls too low.

(8) Oil Filler Cap – Check and fill engine oil level.

(9) Power Panel – See “Power Panel”

Controls and Features

Power Panel

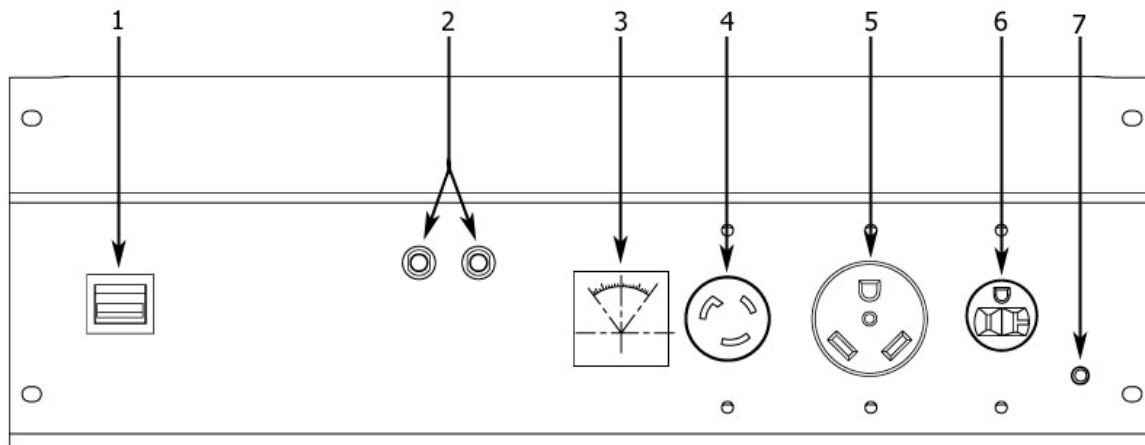

(1) Ignition Switch – Flip switch to the “On” position to start the generator. Flip to the “Off” position to turn off the generator.

(2) Circuit Breakers – Protects the generator against electrical overload.

(3) Voltmeter - Displays the output voltage of the generator.

(4) 120 V 30 A Twist-Lock –This receptacle powers 120 Volt AC, 60 Hz, single phase loads requiring up to 3500 watts of power.

(5) 120 V 30 A Recreational Vehicle (RV) Receptacle –This receptacle powers 120 Volt AC, 60 Hz, single phase loads requiring up to 3500 watts of power.

(6) 120 V 20 A Duplex – This receptacle powers 120 Volt AC, single phase, 60 Hz loads requiring up to 2400 Watts of power.

(7) Ground Terminal – Consult an electrician for local grounding regulations.

Parts Included

Your Model 40049 Gasoline Powered Generator ships with the following parts:

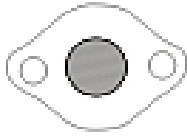

Spark Arrester Kit	
Spark Arrester	1 piece
Cover Plate	1 piece
Screws, Lock Washers	2 pieces

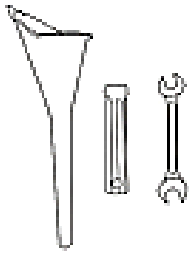

Oil Funnel	1 piece
Wrench	1 piece
Spark Plug Socket	1 piece

Assembly

Assembly

Your generator requires some assembly. This unit ships from our factory without oil. It must be properly serviced with fuel and oil before operation.

If you have any questions regarding the assembly of your generator, call our help line at 1-877-338-0999. Please have your serial number and model number available.

Remove the Generator from the Shipping Carton

1. Set the shipping carton on a solid, flat surface.
2. Remove everything from the carton except the generator.
3. Carefully cut each corner of the box from top to bottom. Fold each side flat on the ground to provide a surface area to set up the generator.

Install the Spark Arrester

Insert the spark arrester screen into the muffler outlet. Secure the spark arrester by placing the cover plate over the end of the screen, with the lettering facing outward.

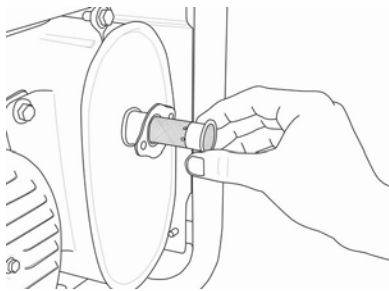

Secure the cover plate with the two screws and lock washers provided with the spark arrester kit.

NOTE

Federal and local laws and administrative requirements indicate when and where spark arresters are required. When ordered, spark arresters are required for operation of this generator in National Forest lands. In California, this generator must not be used on any forest-covered land, brush-covered land, or grass-covered land unless the engine is equipped with a spark arrester.

CAUTION

Failure to install the spark arrester may result in an increased risk of fire.

Add Engine Oil

CAUTION

DO NOT attempt to crank or start the engine before it has been properly filled with the recommended type and amount of oil. Damage to the generator as a result of failure to follow these instructions will void your warranty.

1. Place the generator on a flat, level surface.
2. Remove oil fill cap/dipstick to add oil.

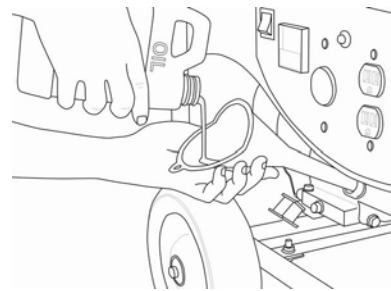

3. Add 0.63 qt (0.6 L) of oil and replace oil fill cap/dipstick. See "Specifications" page in the manual for oil recommendations based on operating conditions.
4. Check engine oil level daily and add as needed.

CAUTION

The engine is equipped with a low-oil-shutoff and the will stop when the oil level in the crankcase falls below the threshold level.

NOTE

Check oil often during the break-in period. Refer to the Maintenance section for recommended service intervals.

NOTE

The generator rotor has a sealed, pre-lubricated ball bearing that requires no additional lubrication for the life of the bearing.

Add Fuel

1. Use clean, fresh, regular unleaded fuel with a minimum octane rating of 85.
2. DO NOT mix oil with fuel.
3. Clean the area around the fuel cap.
4. Remove the fuel cap
5. Slowly add fuel to the tank. DO NOT overfill. Allow approximately ¼ inch of space for fuel expansion.



6. Screw on the fuel cap and wipe away any spilled fuel.

CAUTION

Use regular unleaded gasoline with a minimum octane rating of 85.

Do not mix oil and gasoline.
Fill tank to approximately ¼" below the top of the tank to allow for fuel expansion.
DO NOT fill fuel tank indoors.
DO NOT fill fuel tank when the engine is running or hot.
DO NOT overfill the fuel tank.
DO NOT light cigarettes or smoke when filling the fuel tank.

Grounding

Your generator must be properly connected to an appropriate ground to help prevent electric shock.

WARNING

Failure to properly ground the generator can result in electric shock.

A ground terminal connected to the frame of the generator has been provided on the power panel. For remote grounding, connect of a length of heavy gauge (12 AWG minimum) copper wire between the generator ground terminal and a copper rod driven into the ground. We strongly recommend that you consult with a qualified electrician to ensure compliance with local electrical codes.

Operation

Generator Location

Please consult your local authority. In some areas, generators must be registered with the local utility.

Generators used at construction sites may be subject to additional rules and regulations. This generator must have at least five feet of clearance from combustible material. Leave at least three feet of clearance on all sides of the generator to allow for adequate cooling, maintenance and servicing.

Place the generator in a well-ventilated area. DO NOT place the generator near vents or intakes where exhaust fumes could be drawn into occupied or confined spaces. Carefully consider wind and air currents when positioning generator.

Grounding

The generator system ground connects the frame to the ground terminals on the power panel.

Surge Protection

CAUTION

Voltage fluctuation may impair the proper functioning of sensitive electronic equipment.

Electronic devices, including computers and many programmable appliances use components that are designed to operate within a narrow voltage range and may be affected by momentary voltage fluctuations. While there is no way to prevent voltage fluctuations, you can take steps to protect sensitive electronic equipment.

1. *Install UL1449, CSA-listed, plug-in surge suppressors on the outlets feeding your sensitive equipment.* Surge suppressors come in single- or multi-outlet styles. They're designed to protect against virtually all short-duration voltage fluctuations.

2. *Obtain an Uninterruptible Power Supply (UPS) device.*

Most UPS devices come with a rechargeable battery between the electronic equipment and power supply source. The device buffers the voltage and protects against virtually all short-duration voltage fluctuations.

Starting the Engine

1. Make certain the generator is on a flat, level surface.
2. Disconnect all electrical loads from the generator. Never start or stop the generator with electrical devices plugged in or turned on.
3. Turn the fuel valve to the "On" position.
4. Move the choke lever to the "Choke" position.
5. Flip the ignition switch to the "On" position.
6. Pull the starter cord slowly until resistance is felt and then pull rapidly.
7. As engine warms up, move the choke lever to "Run".

NOTE

If the engine starts but does not run, make certain that the generator is on a flat, level surface. The engine is equipped with a low oil sensor that will prevent the engine from running when the oil level falls below a critical threshold.

Connecting Electrical Loads

1. Let the engine stabilize and warm up for a few minutes after starting.
2. Plug in and turn on the desired 120 Volt AC single phase, 60 Hz electrical loads. DO NOT connect 3-phase loads to the generator. DO NOT connect 50 Hz loads to the generator. DO NOT overload the generator.

Stopping the Engine

1. Turn off and unplug all electrical loads. Never start or stop the generator with electrical devices plugged in or turned on.
2. Let the generator run at no-load for several minutes to stabilize internal

temperatures of the engine and generator.

3. Flip the ignition switch to the "Off" position.
4. Turn the fuel valve to the "Off" position.

Do Not Overload Generator

Capacity

Follow these simple steps to calculate the running and starting watts necessary for your purposes.

1. Select the electrical devices you plan on running at the same time.
2. Total the running watts of these items. This is the amount of power you need to keep your items running.
3. Identify the highest starting wattage of all devices identified in step 1. Add this number to the number calculated in step 2. Surge wattage is the extra burst of power needed to start some electric driven equipment. Following the steps listed under "Power Management" will guarantee that only one device will be starting at a time.

Power Management

Use the following formula to convert voltage and amperage to watts:

$$\text{Volts} \times \text{Amps} = \text{Watts}$$

To prolong the life of your generator and attached devices, follow these steps to add electrical load:

1. Start the generator with no electrical load attached.
2. Allow the engine to run for several minutes to stabilize.
3. Plug in and turn on the first item. It is best to attach the item with the largest load first.
4. Allow the engine to stabilize.
5. Plug in and turn on the next item.
6. Allow the engine to stabilize.
7. Repeat steps 5-6 for each additional item.

NOTE

Never exceed the generator capacity when adding loads.

Operation

Wattage Reference Chart

Use the chart to determine approximate wattage requirements for your equipment.

NOTE

Starting watts can exceed three times the running watts. The values in the following table are approximate. Refer to your tool or appliance for actual wattage consumption.

Item	Running Watts	Starting Watts
Essentials		
Light Bulb 100W	100	
Refrigerator/Freezer	1200	2400
Freezer	500	500
Sump Pump	600	1800
Well Pump 1 HP	2000	4000
Water Heater	4000	
Security System	180	
AM/FM Radio	300	
Garage Door Opener 1/2 HP	500	600
Battery Charger 12V DC	110	
Heating/Cooling		
Air Conditioner 12000 BTU	1700	2500
Fan	300	600
Furnace Fan 1/3 HP	1200	2000
Home Appliances		
Microwave 1000W	1000	
Electric Range - One Element	1500	
Electric Skillet	1250	
Coffee Maker	1500	
Clothes Washer	1200	
Entertainment		
CD/DVD Player	100	
VCR	100	
Stereo Receiver	450	
Television 27"	500	
PC with 15" Monitor	800	
Job Site		
Belt Sander 3"	1000	1500
Bench Grinder 6"	700	1500
Circular Saw	1500	1500
Compressor 1 1/2 HP	2500	2500
Edge Trimmer	500	500
Hand Drill 1/2"	1000	1000
Lawn Mower	1200	1800
Paint Sprayer	600	1200
Table Saw	2000	2000

Maintenance

The owner/operator is responsible for all periodic maintenance.

WARNING

Never operate a damaged or defective generator.

WARNING

Tampering with the factory set governor will void your warranty.

WARNING

Improper maintenance will void your warranty.

Complete all scheduled maintenance in a timely manner. Correct any issue before operating the generator.

NOTE

For service or parts assistance, contact our help line at 1-877-338-0999.

Engine Maintenance

To prevent accidental starting, remove and ground spark plug wire before performing any service.

Oil

Change oil when the engine is warm. Refer to the oil specification to select the proper grade of oil for your operating environment.

1. Remove the oil drain plug with a 15 mm socket and extension.
2. Allow the oil to drain completely.
3. Replace the drain plug.
4. Remove oil fill cap/dipstick to add oil.
5. Add 0.63 qt (0.6 L) of oil and replace oil fill cap/dipstick.

6. Dispose of used oil at an approved waste management facility.

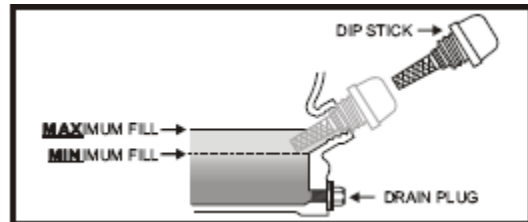

Spark Plugs

1. Remove the spark plug cable from the spark plug.
2. Use the spark plug tool that shipped with your generator to remove the plug.
3. Inspect the electrode on the plug. It must be clean and not worn to produce the spark required for ignition.
4. Make certain the spark plug gap is 0.7 - 0.8mm (0.028 - 0.031 in.).
5. Refer to the spark plug recommendation chart when replacing the plug.
6. Carefully thread the plug into the engine.
7. Use the spark plug tool to firmly install the plug.
8. Attach the spark plug wire to the plug.

Air Filter

1. Remove the snap-on cover holding the air filter to the assembly.
2. Remove the foam element.
3. Wash in liquid detergent and water. Squeeze thoroughly dry in a clean cloth.
4. Saturate in clean engine oil.
5. Squeeze in a clean, absorbent cloth to remove all excess oil.
6. Place the filter in the assembly.
7. Reattach the air filter cover and snap in place.

Maintenance

Spark Arrester

1. Allow the engine to cool completely before servicing the spark arrester.
2. Remove the two screws holding the cover plate which retains the end of the spark arrester to the muffler.
3. Remove the spark arrester screen.
4. Carefully remove the carbon deposits from the spark arrester screen with a wire brush.
5. Replace the spark arrester if it is damaged.
6. Position the spark arrester in the muffler and attach with the two screws.

Cleaning

 CAUTION
DO NOT spray engine with water.
Water can contaminate the fuel system.

Use a damp cloth to clean exterior surfaces of the engine.

Use a soft bristle brush to remove dirt and oil.

Use an air compressor (25 PSI) to clear dirt and debris from the engine.

Adjustments

The air-fuel mixture is not adjustable. Tampering with the governor can damage your generator and your electrical devices and will void your warranty. CPE recommends that you contact our service line at 1-877-338-0999 for all other service and/or adjustment needs.

Maintenance Schedule

Follow the service intervals indicated in the schedule below.

Service your generator more frequently when operating in adverse conditions. Contact our help line at 1-877-338-0999 to locate the nearest Champion Power Equipment certified service dealer for your generator or engine maintenance needs.

Every 8 hours or daily
Check oil level
Clean around air intake and muffler
First 5 Hours
Change oil
Every 50 hours or every season
Clean air filter
Change oil if operating under heavy load or in hot environments
Every 100 hours or every season
Change oil
Clean/Adjust spark plug
Check/Adjust valve clearance *
Clean spark arrester
Clean fuel tank and filter *
Every 3 years
Replace fuel line

* To be performed by knowledgeable, experienced owners or Champion Power Equipment certified service dealers

Generator Maintenance

Make certain that the generator is kept clean and stored properly. Only operate the unit on a flat, level surface in a clean, dry operating environment. **DO NOT** expose the unit to extreme conditions, excessive dust, dirt, moisture or corrosive vapors.

 CAUTION
DO NOT use a garden hose to clean the generator.
Water can enter the generator through the cooling slots and damage the generator windings.

Use a damp cloth to clean exterior surfaces of the generator.

Use a soft bristle brush to remove dirt and oil.

Use an air compressor (25 PSI) to clear dirt and debris from the generator.

Inspect all air vents and cooling slots to ensure that they are clean and unobstructed.

Storage

The generator should be started at least once every 14 days and allowed to run for at least 20 minutes. For longer term storage, please follow these guidelines.

Engine Storage

1. Allow the engine to cool completely before storage.
2. Clean the engine according to the instructions in the Maintenance section.
3. Drain all fuel completely from the fuel line and carburetor to prevent gum from forming.
4. Add a fuel stabilizer into the fuel tank.

5. Change the oil.
6. Remove the spark plug and pour about $\frac{1}{2}$ ounce of oil into the cylinder. Crank the engine slowly to distribute the oil and lubricate the cylinder.
7. Reattach the spark plug.

Generator Storage

1. Allow the generator to cool completely before storage.
2. Turn off the fuel supply at the fuel valve.
3. Clean the generator according to the instructions in the Maintenance section.
4. Store the unit in a clean, dry area.
5. Store in a clean, dry place out of direct sunlight.

Specifications

Specifications

Engine Specifications

Engine 196 cc OHV CPE

Generator Specifications

Running Wattage	3500 Watts
Starting Wattage	4000 Watts
AC Load	120 V
Phase	Single
Frequency	60 Hz
Fuel Capacity	3.8 gallons (14.4 L)
Weight	103.6 lbs. (47 kg)
Height	17.5 inches (44.5 cm)
Width	17.5 inches (44.5 cm)
Length	23.2 inches (59.0 cm)

Fuel

Fuel capacity is 3.8 US gallons (14.4 L). Use regular unleaded gasoline with a minimum octane rating of 85.

Oil

Oil capacity is 0.63 qt (0.6 L).

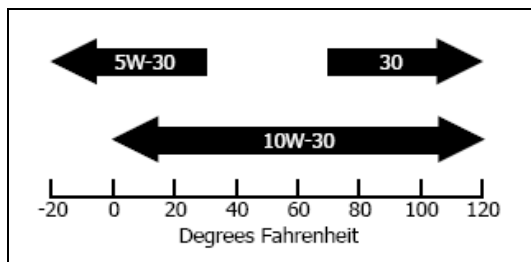

Spark Plugs

Your generator comes equipped with a 3/4" long reach plug (18mm)

Intermittent use (less than 1 hour/month) or colder temperatures (below 60°F)
NGK B6ES or equivalent

Moderate use (less than 3 hours/month) or seasonal temperatures (50-80°F)
NGK B7ES or equivalent

Extreme use (continuous) or hot climates (80-100°F)
NGK B8ES or equivalent

Make certain the spark plug gap is 0.7 - 0.8mm (0.028 - 0.031 in.).

Valve Clearance

Intake 0.13-0.17mm (0.005 – 0.007 in.)
Exhaust 0.18-0.22mm (0.007 – 0.009 in.)

Parts Diagram

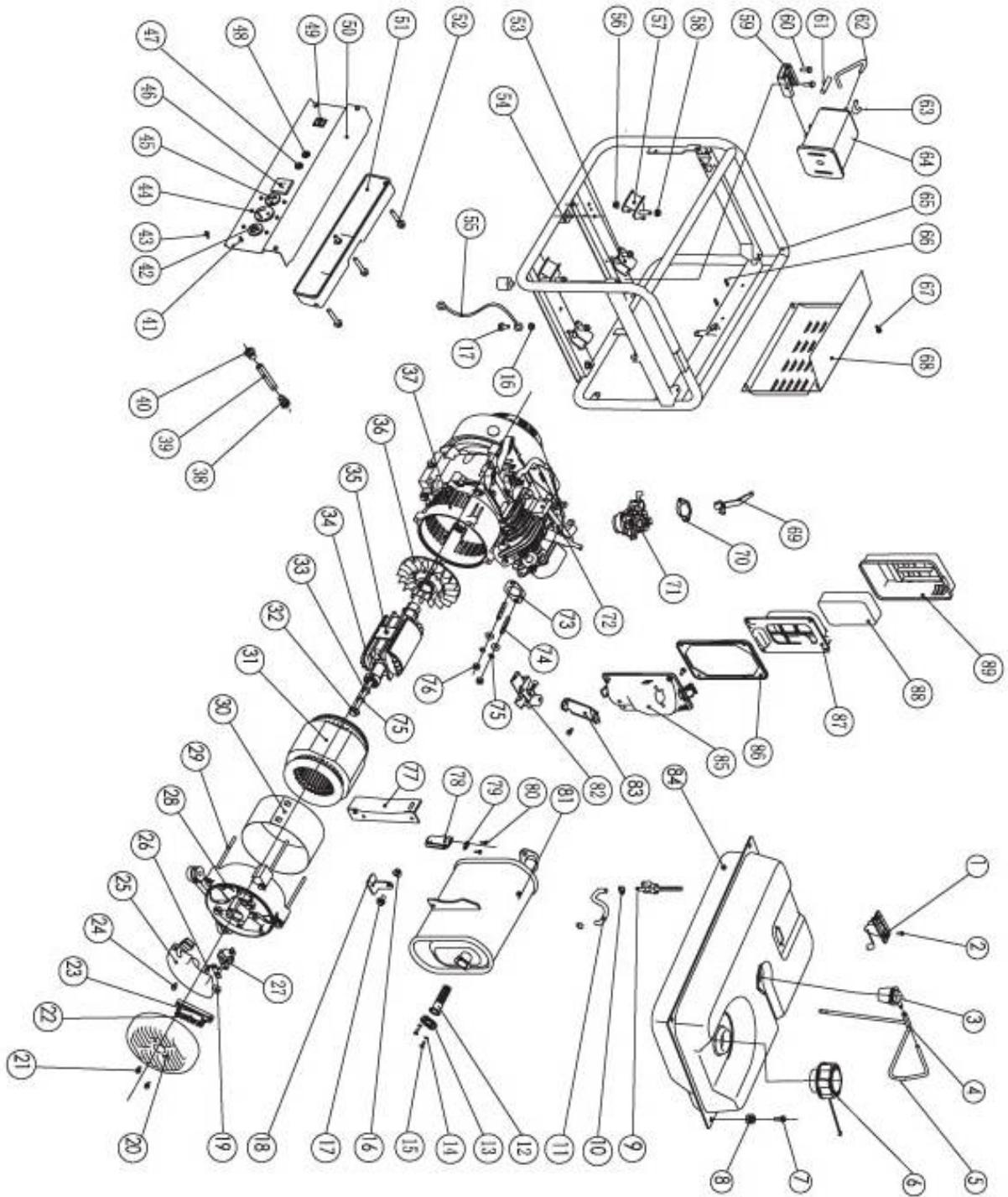

Specifications

Parts List

Item	Part Number	Description	Qty
1	ST168FD-1160100	Fuel Meter Assembly	1
2	GB819-85-S5-6	Screw M5×6	2
3	ST168FD-1160301-CARB	Rollover Valve	1
4	ST168FD-1160306-CARB	Hose	2
5	ST168FD-1160302-CARB	Rollover Valve Hose	1
6	ST168FD-1160200-CARB	Fuel Tank Cap	1
7	GB5789-86-FB6-20	Flange Bolt M6×20	4
8	ST168FD-1163000	Tank Rubber	4
9	ST168FD-1160400	Fuel Cock	1
10	ST188FD-1070006A	Clip	2
11	ST168FD-1160002A	Fuel Hose	1
12	ST188FD-1180121	Spark Arrester Assembly	1
13	ST188FD-1100010-88	Spark Arrester Cover	1
14	GB93-1987-SW5	Spring Washer φ5	2
15	GB5789-86-FB5-15	Flange Bolt M5×15	2
16	GB6177-86-N6	Nut M6	1
17	GB5789-86-FB6-15	Flange BoltM6×15	1
18	ST168FD-1100002B	Muffler Stay(1)	1
19	ST02FD-1151036	Brush Assy Cover Board	1
20	ST02FD-1152002-2	Generator End Cover	1
21	GB5789-86-FB5-10	Flange Bolt M5×10	2
22	ST168FD-1150230	Terminal	1
23	GB5781-87-B5-16	BoltM5×16	2
24	GB5781-86-B5-15	BoltM5×15	2
25	ST168FD-1152031	AVR	1
26	GB5781-87-B5-20	BoltM5×20	2
27	ST02FD-1152035	Brush Assembly	1
28	ST02FD-1152032	End Cover	1
29	GB5789-86-FB6-158	Flange BoltM6×158	4
30	ST02FD-1152001	Stator Cover	1
31	ST02FD-1152020	Stator Assembly	1
32	GB5780-86-FB8-233	Flange Bolt M8×233	1
33	GB90-85-W8	Washer φ8	1
34	GB279-88 6202	Bearing	1
35	ST02FD-1152010	Rotor Comp	1
36	ST02FD-1152009	Cooling Fan	1
37	ST168FD-1030007	Crankcase Cover	1
38	ST05FD-1170003-B	Grommet	1
39	ST05FD-1151209-1	Conduit	1
40	ST02FD-1151201	Grommet	1
41	ST02FD-1151208-M	Grounding Bolt	1
42	ST02FD-1151202M	5-20R Receptacle	1
43	ST02FD-05010703	Bolt M5×13	4
44	1010	RV Receptacle	1
45	ST02FD-05050220	Receptacle L5-30R	1
46	ST02FD-1151204A	Volt Meter	1
47	ST02FD-1151202A-20	AC.20A Circuit Breakers	1
48	ST02FD-1151202A-25	AC.25A Circuit Breakers	1
49	ST05FD-05705005	Engine Switch	1
50	ST05FD-05015600	Control Panel	1
51	ST02FD-1151300	Control Box	1

Specifications

Item	Part Number	Description	Qty
52	GB818-85-S5-35	Screw M5×35	3
53	ST02FD-1151300B	Bottom Rubber I	2
54	ST02FD-1151400	Frame Rubber	4
55	ST02FD-1151207-M	Grounding Line	1
56	GB6177-86-N8	Nut M8	16
57	ST02FD-1151300A	Bottom Rubber II	2
58	GB6177-86-N8	Nut M8	4
59	ST02FD-1180011-CARB	Charcoal Canister	1
60	GB5789-86	Flange Bolt M8×12	2
61	ST168FD-1160304-CARB	Air Hose	1
62	ST168FD-1160307-CARB	Air Cleaner Hose	1
63	ST168FD-1160305-CARB	90° Elbow	1
64	ST168FD-1160400-CARB	Canister	1
65	ST02FD-036	Frame	1
66	ST168FD-1160306-CARB	Clip	2
67	GB5789-86-FB6-12	Flange Bolt M6×12	6
68	ST02FD-1151002	Muffler Cover	1
69	ST02FD-1151201A	Choke Lever Comp	1
70	ST168FD-1130005	Packing	1
71	ST168FD-II-1130003-CPE	Carburetor	1
72	ST168F-II-1000000	Engine	1
73	ST160F-1100001	Muffler Gasket	1
74	GB900-88	Stud Bolt	2
75	GB93-1987-SW8	Spring Washer φ8	3
76	GB6170-86-N8	Nut M8	2
77	ST02FD-1150100	Muffler Stay (II)	1
78	ST168FD-1100500-CARB	Air Fill Clique	1
79	ST168FD-1100305-CARB	Air Fill Clique Washer	1
80	GB5787-86	Flange Bolt M6×12	2
81	ST168FD-1100200-CARB	Muffler	1
82	ST168FD-1111100	Control Assembly	1
83	ST168FD-1090006	Air Cleaner Stay	1
84	ST168FD-1160100-CARB	Fuel Tank	1
85	ST168FD-1090004-CARB	Air Cleaner Case Comp	1
86	ST168FD-1090002	Air Cleaner Seal	1
87	ST168FD-1090003	Separator	1
88	ST168FD-1090004	Element	1
89	ST168FD-1090200	Air Cleaner Cover Comp	1

Specifications

Wiring Diagram

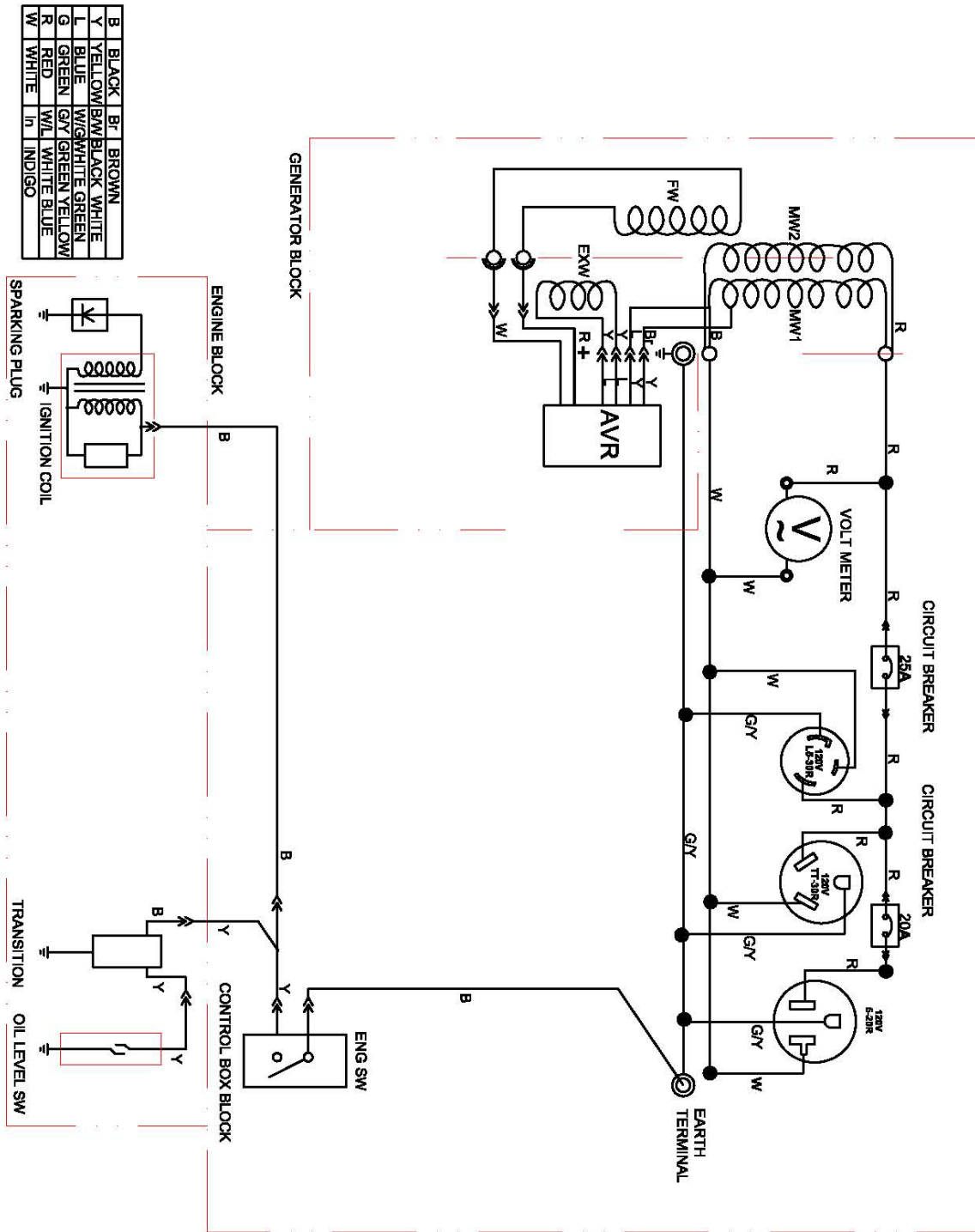

Troubleshooting

Problem	Cause	Solution
Generator will not start	No fuel	Add fuel
	Faulty spark plug	Replace spark plug
	Unit loaded during start up	Remove load from unit
Generator will not start; Generator starts but runs roughly	Low oil level	Fill crankcase to the proper level Place generator on a flat, level surface
	Choke in the wrong position.	Adjust choke.
	Spark plug wire loose	Attach wire to spark plug
Generator shuts down during operation	Out of fuel	Fill fuel tank
	Low oil level	Fill crankcase to the proper level. Place generator on a flat, level surface
Generator cannot supply enough power or overheating	Generator is overloaded	Review load and adjust. See "Power Management"
	Insufficient ventilation	Check for air restriction. Move to a well ventilated area
No AC output	Cable not properly connected	Check all connections
	Connected device is defective	Replace defective device
	Circuit breaker is open	Reset circuit breaker
	Capacitor defective	Replace capacitor (Service Center)
	Faulty brush assembly	Replace brush assembly (Service Center)
	Faulty AVR (auto voltage regulator)	Replace AVR (auto voltage regulator) (Service Center)
	Loose wiring	Inspect and tighten wiring connections
Other	Contact the help line.	
Generator gallops	Engine governor defective	Contact the help line
Repeated circuit breaker tripping	Overload	Review load and adjust. See "Power Management"
	Faulty cords or device	Check for damaged, bare or frayed wires. Replace defective device

Warranty

Warranty

CHAMPION POWER EQUIPMENT 1 YEAR LIMITED WARRANTY

Effective September 1, 2006. Replaces all undated warranties and all warranties dated before September 1, 2006.

Warranty Qualifications

Champion Power Equipment (CPE) will register this warranty upon receipt of your Warranty Registration Card and a copy of your sales receipt from one of CPE's retail locations as proof of purchase.

Please submit your warranty registration and your proof of purchase within ten (10) days of the date of purchase.

Repair/Replacement Warranty

CPE warrants to the original purchaser that the mechanical and electrical components will be free of defects in material and workmanship for a period of one (1) year from the original date of purchase (90 days for commercial & industrial use). Transportation charges on product submitted for repair or replacement under this warranty are the sole responsibility of the purchaser. This warranty only applies to the original purchaser and is not transferable.

Do not return the unit to the place of purchase

Contact CPE's Technical Service and CPE will troubleshoot any issue via phone or e-mail. If the problem is not corrected by this method, CPE will, at its option, authorize evaluation, repair or replacement of the defective part or component at a CPE Service Center. CPE will provide you with a case number for warranty service. Please keep it for future reference. Repairs or replacements without prior authorization, or at an unauthorized repair facility, will not be covered by this warranty.

Warranty Exclusions

This warranty does not cover the following repairs and equipment:

Normal Wear

Generators need periodic parts and service to perform well. This warranty does not cover repair when normal use has exhausted the life of a part or the equipment as a whole.

Installation, Use and Maintenance

This warranty will not apply to parts and/or labor if this generator is deemed to have been misused, neglected, involved in an accident, abused, loaded beyond the generator's limits, modified, installed improperly or connected incorrectly to any electrical component. Normal maintenance such as spark plugs, air filters, adjustments, fuel system cleaning and obstruction due to buildup is not covered by this warranty.

Other Exclusions

This warranty excludes:

Cosmetic defects such as paint, decals, etc.
Wear items such as filter elements, o-rings, etc.

Accessory parts such as starting batteries, and storage covers.

Failures due to acts of God and other force majeure events beyond the manufacturer's control.

Problems caused by parts that are not original Champion Power Equipment parts.

This warranty does not apply to generators used for prime power in place of a utility.

Limits of Implied Warranty and Consequential Damage

Champion Power Equipment disclaims any obligation to cover any loss of time, use of this product, freight, or any incidental or consequential claim by anyone from using this generator. THIS WARRANTY IS IN LIEU OF ALL OTHER WARRANTIES, EXPRESS OR IMPLIED, INCLUDING WARRANTIES OF MERCHANTABILITY OR FITNESS FOR A PARTICULAR PURPOSE

A unit provided as an exchange will be subject to the warranty of the original unit. The length of the warranty governing the exchanged unit will remain calculated by reference to the purchase date of the original unit.

This warranty gives you certain legal rights which may change from state to state. Your state may also have other rights you may be entitled to that are not listed within this warranty.

Contact Information

Address

Champion Power Equipment, Inc.
Customer Service
10006 Santa Fe Springs Rd.
Santa Fe Springs, CA 90670

Customer Service

Mon – Fri 8:30 AM – 5:00 PM (PST/PDT)
Toll Free: 1-877-338-0999
Fax no.: 1-562-236-9429

Technical Service

Mon – Fri 8:30 AM – 5:00 PM (PST/PDT)
Toll Free: 1-877-338-0999
tech@championpowerequipment.com

Warranty

**Champion Power Equipment, Inc (CPE),
The California Air Resources Board (CARB) and the United States Environment Protection
Agency (U.S. EPA.)
Emission Control System Warranty**

Your Champion Power Equipment (CPE) engine complies with both the U.S. EPA and state of California Air Resources Board (CARB) emission regulations.

YOUR WARRANTY RIGHTS AND OBLIGATIONS:

The California Air Resources Board, US EPA AND CPE are pleased to explain the Federal and California Emission Control Systems Warranty on your 2008 small off-road engine. In California, new, small off-road engines must be designed, built and equipped to meet the State's stringent anti smog standards. In the other states, new engines must be designed, built and equipped, at the time of sale, to meet U.S. EPA regulations for small non-road engines. CPE must warrant the emission control system on your small off-road engine for the period of time listed below, provided there has been no abuse, neglect, unapproved modification, or improper maintenance of your small off-road engine.

Your emission control system may include parts such as the carburetor, fuel-injection system, the ignition system, catalytic converter and fuel lines. Also included may be hoses, belts, connectors and other emission related assemblies. Where a warrantable condition exists, CPE will repair your small off-road engine at no cost to you including diagnosis, parts and labor.

MANUFACTURER'S EMISSION CONTROL SYSTEM WARRANTY COVERAGE:

This emission control system is warranted for two years, subject to provisions set forth below. If, during the warranty period, emission related part on your engine is defective in materials or workmanship, the part will be repaired or replaced by CPE.

OWNER WARRANTY RESPONSIBILITIES:

As the small off-road engine owner, you are responsible for the performance of the required maintenance listed in your Owner's Manual. CPE recommends that you retain all your receipts covering maintenance on your small off-road engine, but CPE cannot deny warranty solely for the lack of receipts or for your failure to ensure the performance of all scheduled maintenance.

As the small off-road engine owner, you should however be aware that CPE may deny you warranty coverage if your small, off-road engine or a part has failed due to abuse, neglect, improper maintenance or unapproved modifications.

You are responsible for presenting your small off-road engine to an Authorized CPE service outlet, CPE dealer or CPE, Santa Fe Springs, Ca. as soon as a problem exists. The warranty repairs should be completed in a reasonable amount of time, not to exceed 30 days.

If you have any questions regarding your warranty rights and responsibilities, you should contact:

Champion Power Equipment, Inc.
Customer Service
10006 Santa Fe Springs Road
Santa Fe Springs, CA 90670
Tel: 1-877-338-0999

The emission warranty is a defects warranty. Defects are judged on normal engine performance. The warranty is not related to an in-use emission test.

EMISSION CONTROL SYSTEM WARRANTY

The following are specific provisions relative to your Emission Control System Warranty Coverage.

Emission Control System Warranty (ECS Warranty) for 1995 and later model year California small off-road engines (for other states, 1997 and later model year engines):

1. APPLICABILITY: This warranty shall apply to 1995 and later model year California small off-road engines (for other states, 1997 and later model year engines). The ECS Warranty Period shall begin on the date the new engine or equipment is delivered to its original, end-use purchaser, and shall continue for 24 consecutive months thereafter.

2. GENERAL EMISSIONS WARRANTY COVERAGE

CPE warrants to the original, end-use purchaser of the new engine or equipment and to each subsequent purchaser that each of its small off-road engines is:

- a. Designed, built and equipped so as to conform with all applicable regulations adopted by the Air Resources Board pursuant to its authority in Chapters 1 and 2, Part 5, Division 26 of the Health and Safety Code, and
- b. Free from defects in materials and workmanship that cause the failure of a warranted part to be identical in all material respects to the part as described in the engine manufacturer's application for certification for a period of two years.

3. THE WARRANTY ON EMISSION-RELATED PARTS WILL BE INTERPRETED AS FOLLOWS:

a. Any warranted part that is not scheduled for replacement as required maintenance in the Owners Manual shall be warranted for the ECS Warranty Period. If any such part fails during the ECS Warranty Period, it shall be repaired or replaced by CPE according to Subsection "d" below. Any such part repaired or replaced under the ECS Warranty shall be warranted for any remainder of the ECS Warranty Period.

b. Any warranted, emissions-related part which is scheduled only for regular inspection as specified in the Owners Manual shall be warranted for the ECS Warranty Period. A statement in such written instructions to the effect of "repair or replace as necessary", shall not reduce the ECS Warranty Period. Any such part repaired or replaced under the ECS Warranty shall be warranted for the remainder of the ECS Warranty Period.

c. Any warranted, emissions-related part which is scheduled for replacement as required maintenance in the Owner's Manual shall be warranted for the period of time prior to the first scheduled replacement point for that part. If the part fails prior to the first scheduled replacement, the part shall be repaired or replaced by CPE according to Subsection "d" below. Any such emissions-related part repaired or replaced under the ECS Warranty, shall be warranted for the remainder of the ECS Warranty Period prior to the first scheduled replacement point for such emissions-related part.

d. Repair or replacement of any warranted, emissions-related part under this ECS Warranty shall be performed at no charge to the owner at a CPE Authorized Service Outlet.

e. The owner shall not be charged for diagnostic labor which leads to the determination that a part covered by the ECS Warranty is in fact defective, provided that such diagnostic work is performed at a CPE Authorized Service Outlet.

f. CPE shall be liable for damages to other original engine components or approved modifications proximately caused by a failure under warranty of an emission-related part covered by the ECS Warranty.

g. Throughout the ECS Warranty Period, CPE shall maintain a supply of warranted emission-related parts sufficient to meet the expected demand for such emission-related parts.

Warranty

h. Any CPE Authorized and approved emission-related replacement part may be used in the performance of any ECS Warranty maintenance or repair and will be provided without charge to the owner. Such use shall not reduce CPE's warranty obligation.

i. Unapproved add-on or modified parts may not be used to modify or repair a CPE engine. Such use voids this ECS Warranty and shall be sufficient grounds for disallowing an ECS Warranty claim. CPE shall not be liable hereunder for failures of any warranted parts of a CPE engine caused by the use of such an unapproved add-on or modified part.

EMISSION-RELATED PARTS INCLUDE THE FOLLOWING: (using those portions of the list applicable to the engine)

Systems covered by this warranty	Parts Description
Fuel Metering System	Fuel regulator, Carburetor and internal parts
Air Induction System	Air cleaner, Intake manifold
Ignition System	Spark plug and parts, Magneto ignition system
Exhaust System	Exhaust manifold, catalytic converter
Miscellaneous Parts	Tubing, Fittings, Seals, Gaskets, and Clamps associated with these listed systems
Evaporative Emissions	Fuel Tank, Fuel Cap, Fuel Line, Fuel Line Fittings, Clamps, Pressure Relief Valves, Control Valves, Control Solenoids, Electronic Controls, Vacuum Control Diaphragms, Control Cables, Control Linkages, Purge Valves, Vapor Hoses, Liquid/Vapor Separator, Carbon Canister, Canister Mounting Brackets, Carburetor Purge Port Connector

TO OBTAIN WARRANTY SERVICE:

You must take your CPE engine or the product on which it is installed, along with your warranty registration card or other proof of original purchase date, at your expense, to any Champion Power Equipment dealer who is authorized by Champion Power Equipment, Inc. to sell and service that CPE product during his normal business hours. Claims for repair or adjustment found to be caused solely by defects in material or workmanship will not be denied because the engine was not properly maintained and used.

If you have any questions regarding your warranty rights and responsibilities, or to obtain warranty service, please write or call the Customer service of Champion Power Equipment, Inc.

**Champion Power Equipment, Inc.
10006 Santa Fe Springs Road
Santa Fe Springs, CA 90670
1-877-338-0999
Attn: Customer Service**

Notes